

AM-FM STEREO RECEIVER

KR-A2080/A3080/A4080/A5080

SERVICE MANUAL

KENWOOD

© 1996-4/B51-5169-00 (K/K) 3962

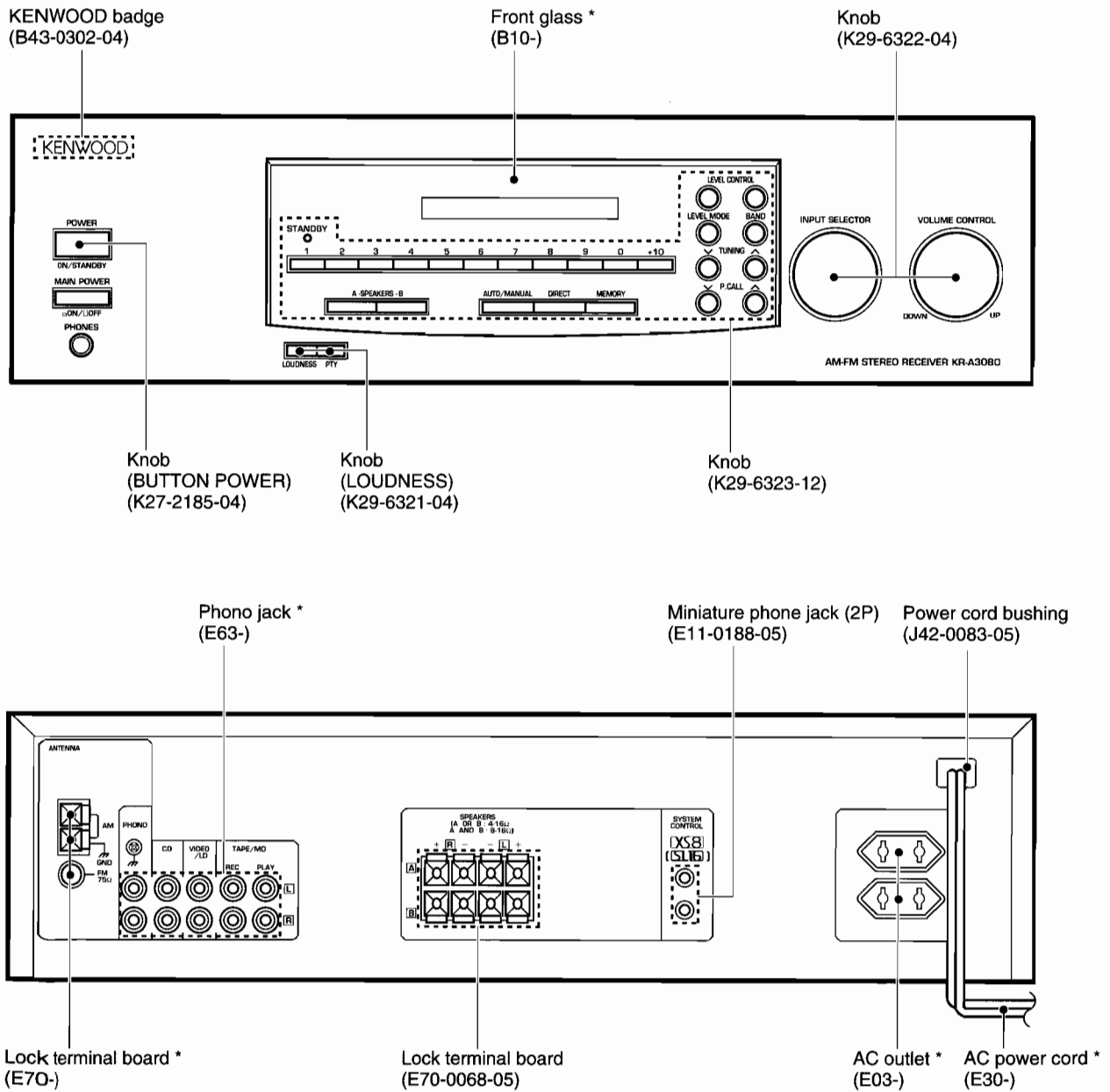

Illustration is KR-A3080.

* Refer to parts list on page 33.

PRECAUTIONS FOR REPAIR

• For the serial test mode, see Service Manual (B51-5162-00) of KR-V7080/V8080.

KR-A2080/A3080/A4080/A5080

CONTENTS / ACCESSORIES / CONTROL

Contents

CONTENTS / ACCESSORIES / CAUTION	2	WIRING DIAGRAM	14
REMOTE CONTROL UNIT	3	PC BOARD	15
EXTERNAL VIEW	4	SCHEMATIC DIAGRAM	19
DISASSEMBLY FOR REPAIR	5	EXPLODED VIEW	31
BLOCK DIAGRAM	6	PARTS LIST.....	33
CIRCUIT DESCRIPTION	7	SPECIFICATIONS	43
ADJUSTMENT	13		

Accessories

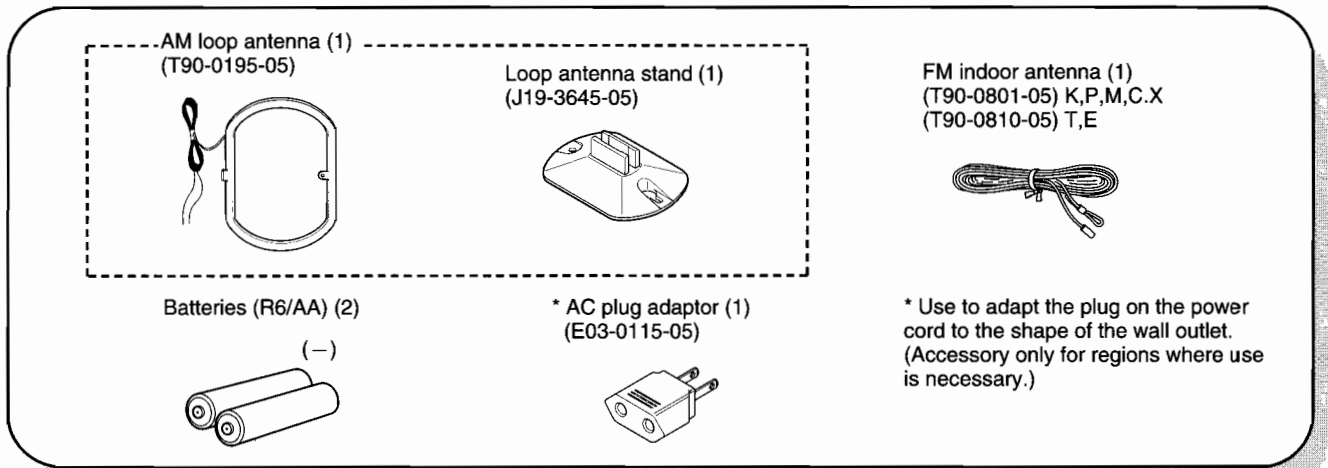

Caution

SWITCHING FROM [XS8] TO [SL16]

You can easily change the system control mode with the following operation. Do this operation after completing all connections.

Switching to [SL16] : Hold down the AUTO key and switch the MAIN POWER key from OFF to ON.

Switching back to [XS8] : Hold down the BAND key and switch the MAIN POWER key from OFF to ON.

- This operation will not affect items stored in the memory.

Note : The system control mode will revert to [XS8] if the unit is not turned on for three consecutive days. If you would like to make the unit completely (and permanently) [SL16] compatible, please consult your nearest retailer or the Kenwood Marketing Department.

- There is the U-Com (hard) match method.

KR-A2080/A3080/A4080/A5080

REMOTE CONTROL UNIT

(A70-1044-05) : KR-A4080/5080 K,P,C,M,X

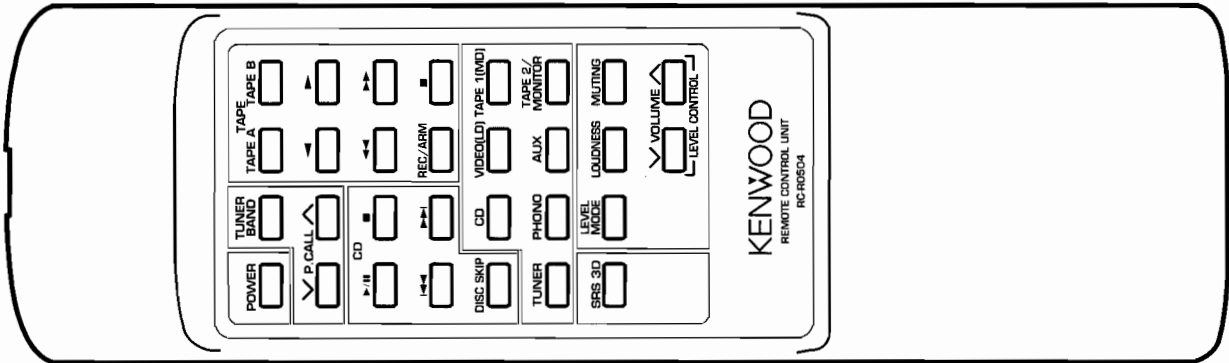

(A70-1045-05) : KR-A4080/5080 T,E

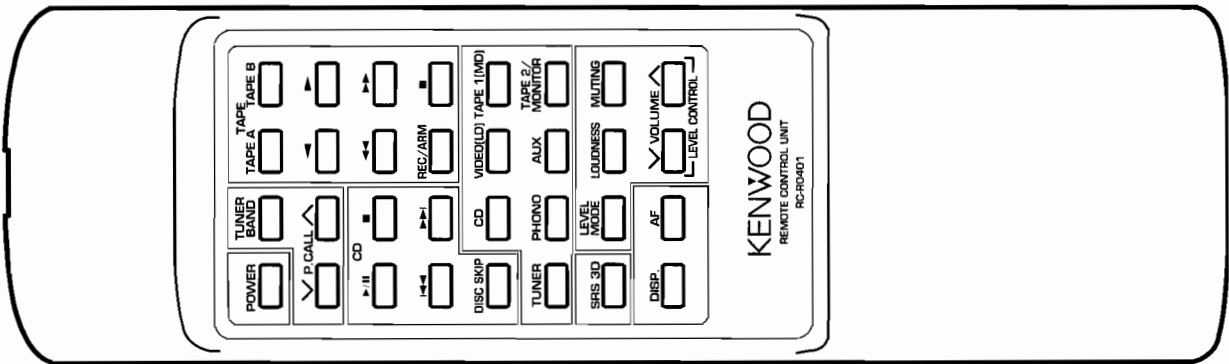

(A70-1057-05) : KR-A3080 K,P,M

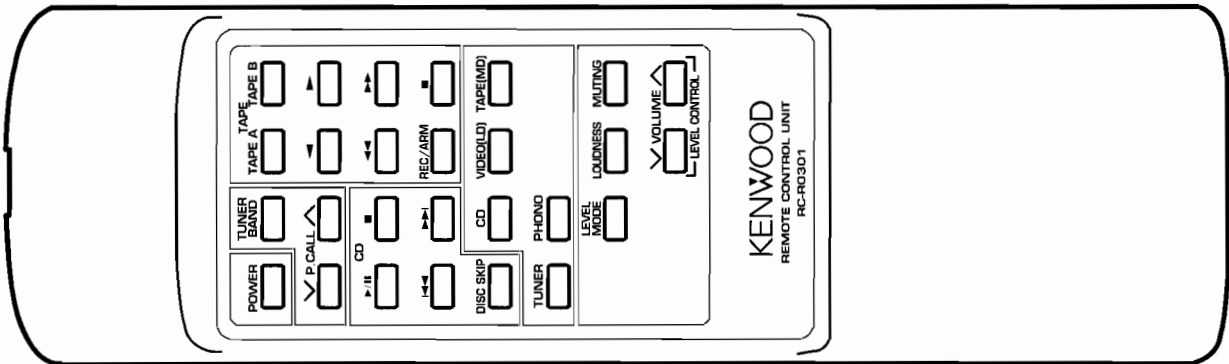

(A70-1058-05) : KR-A3080 T,E

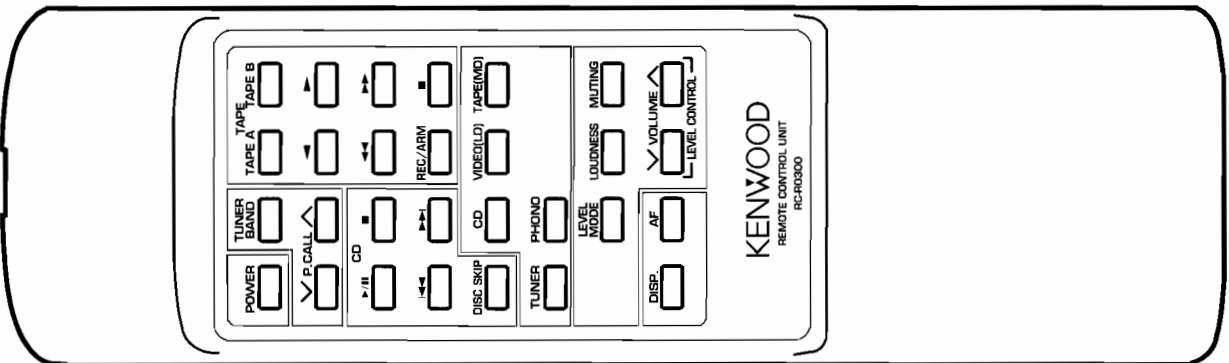

KR-A2080/A3080/A4080/A5080

EXTERNAL VIEW

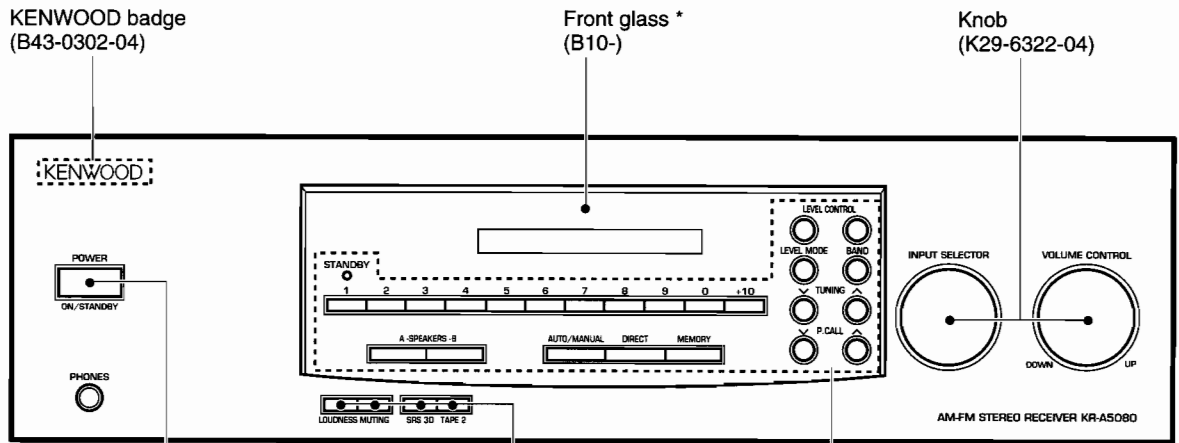

Knob
(BUTTON POWER)
(K27-2185-04)

Knob
(LOUDNESS)
(K29-6321-04)

Knob
(K29-6323-12)

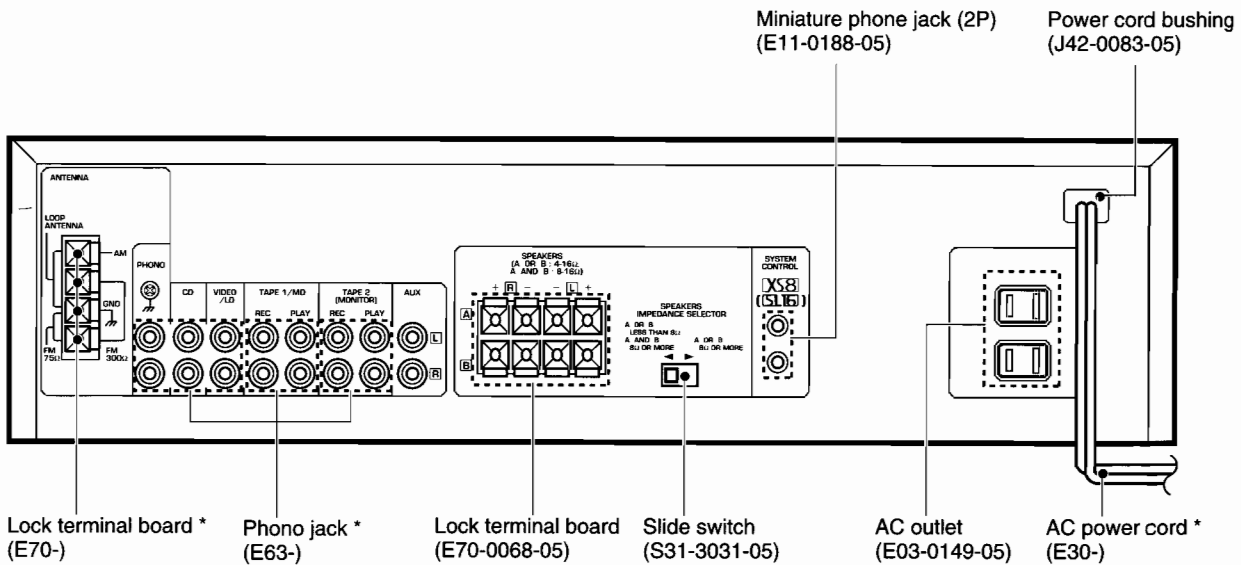

Lock terminal board *
(E70-)

Phono jack *
(E63-)

Lock terminal board
(E70-0068-05)

Slide switch
(S31-3031-05)

AC outlet
(E03-0149-05)

AC power cord *
(E30-)

Illustration is KR-A5080.

* Refer to parts list on page 33.

KR-A2080/A3080/A4080/A5080

DISASSEMBLY FOR REPAIR

- 1) Remove the 4 screws (❶), then remove the front panel.

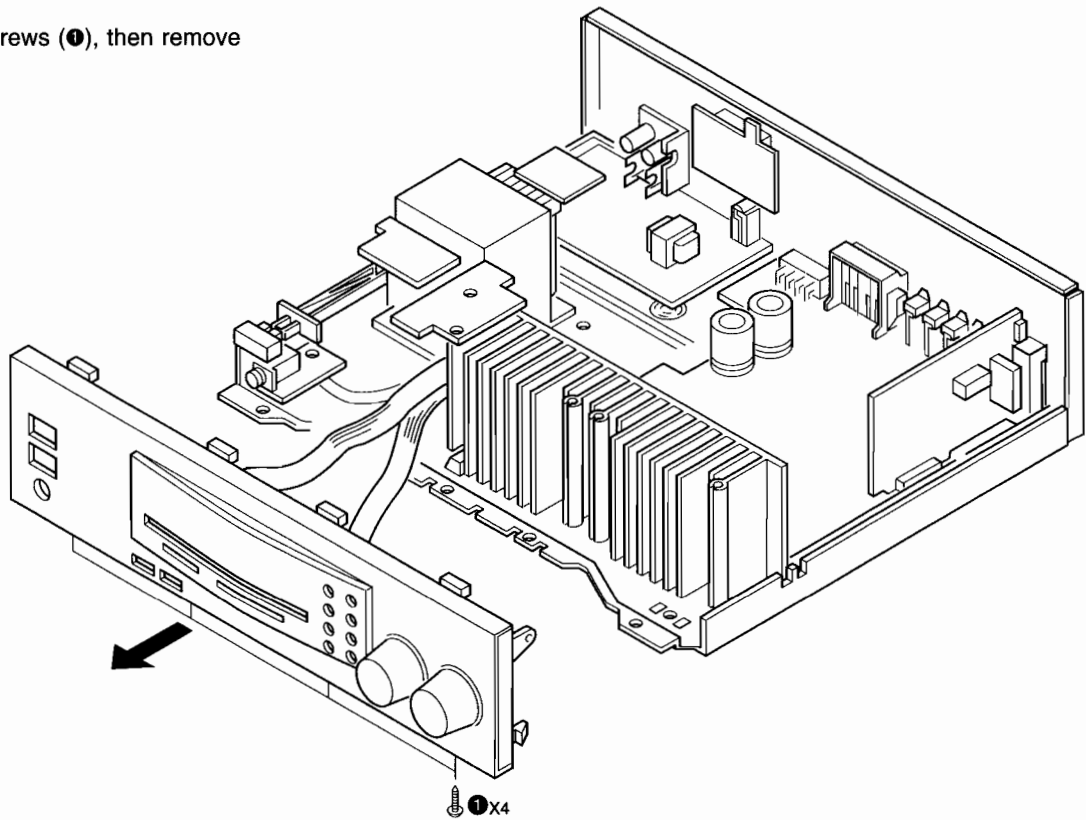

- 2) Remove the power knob (❷) and the 14 screws (❸).
- 3) Put the doth (❹) on the power transformer, then remove main PCB and rear panel assembly (❺).

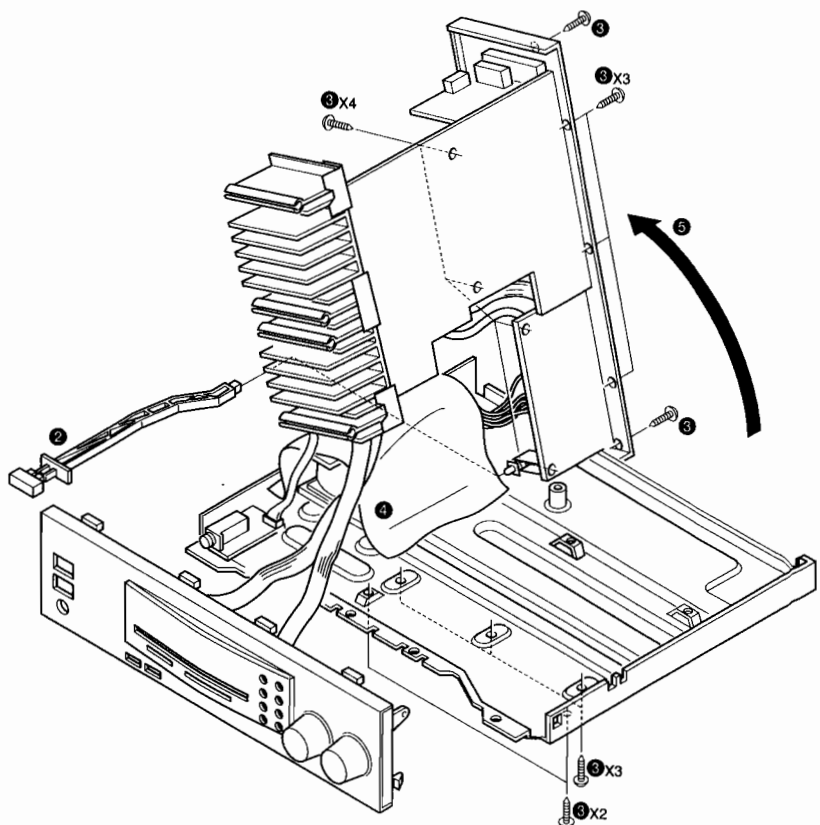

KR-A2080/A3080/A4080/A5080

BLOCK DIAGRAM

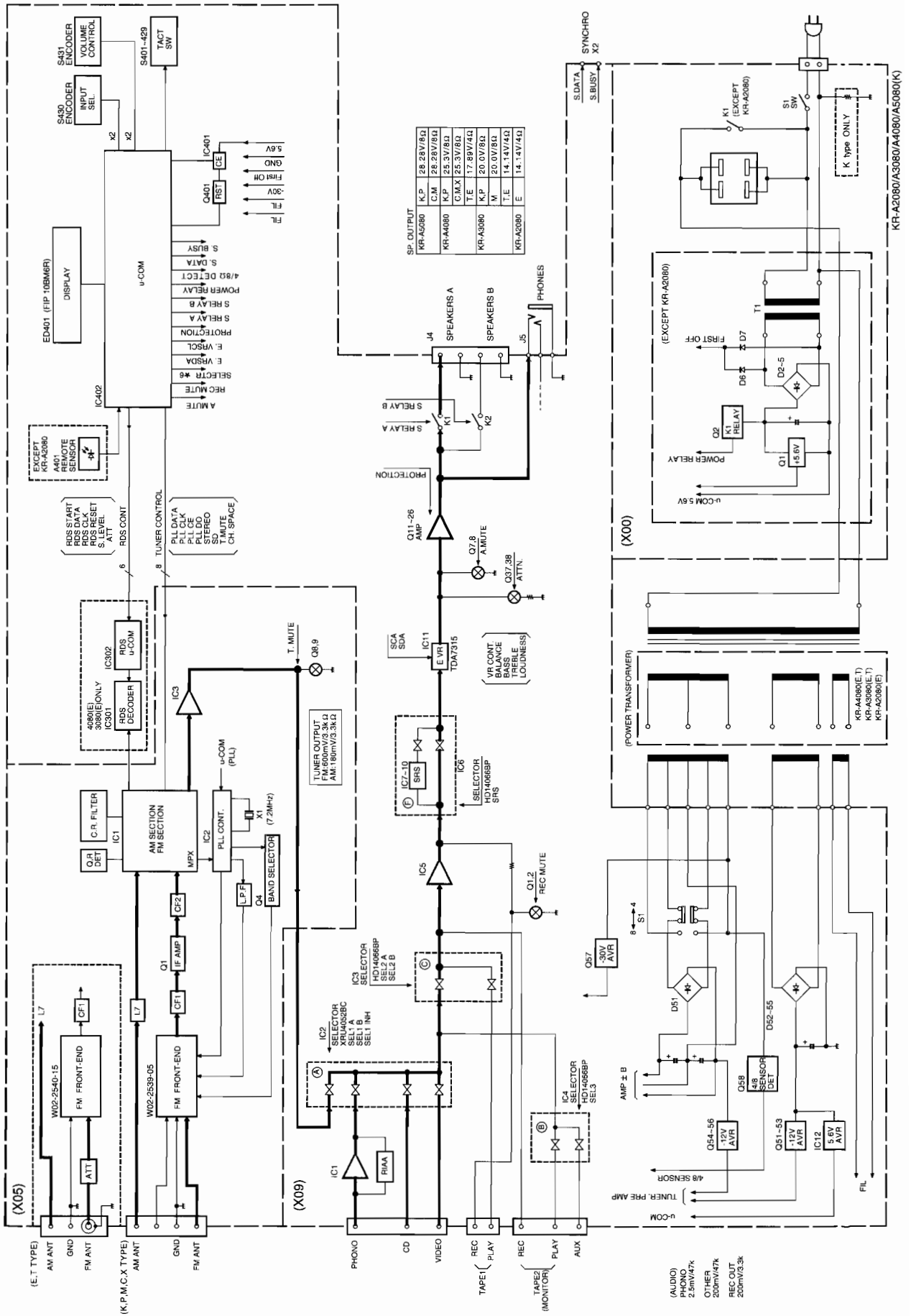

KR-A2080/A3080/A4080/A5080

CIRCUIT DESCRIPTION

1. MAIN μ -COM (X09: IC402) : UPD78043AGF040 K,P,M,X type
 : UPD78044AGF162 T,E type

1-1. Microprocessor periphery block diagram

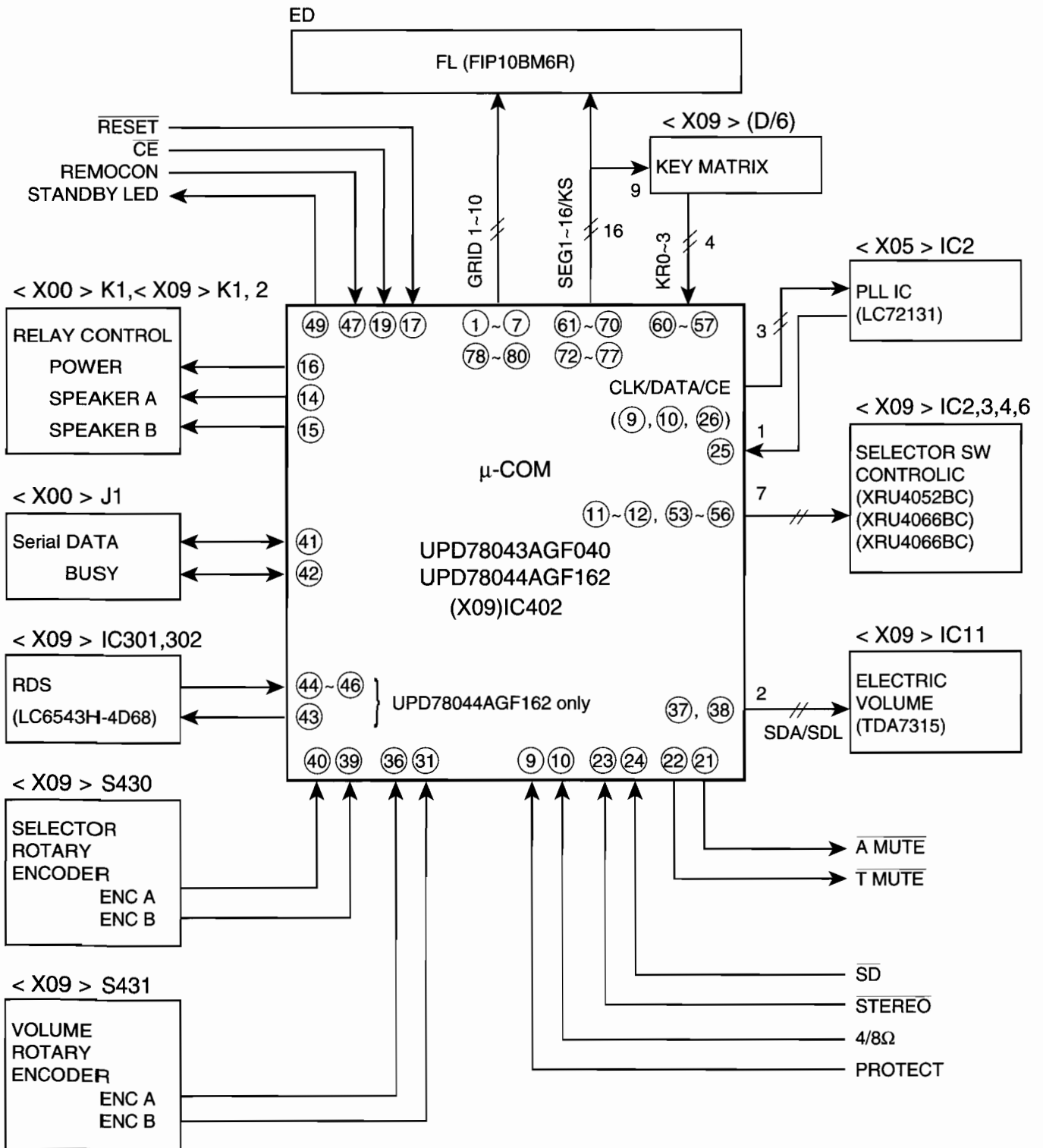

KR-A2080/A3080/A4080/A5080

CIRCUIT DESCRIPTION

1-2. Pin description

No.	Name	I/O	Description
1-7	G7-G1	O	Display digit control (Grid7-Grid1)
8	VDD		Power supply (+5V)
9	PROTECT	I	Protection detection
	PLLCLOCK	O	Control clock for PLL IC H : ON
10	4/8 Ω	I	Speaker impedance changeover detection H : 4 Ω L : 8 Ω
	PLLDATA	O	Control data for PLL IC
11	SEL1 A	O	Control output A for selector IC 1
12	SEL1 B	O	Control output B for selector IC 1
13	SEL1 INH	O	Control output INH for selector IC 1
14	A SP	O	A SP relay control H : ON L : OFF
15	B SP	O	B SP relay control H : ON L : OFF
16	POWER	O	Power relay control H : ON L : OFF
17	RESET	I	Reset input
18	VOL ATT	O	VOL ATT control H : OFF L : ON
19	CE	I	AC OFF (MAIN POWER) detection signal L : AC OFF
20	AVSS		A/D power supply (GND)
21	A MUTE	O	Analog mute signal L : ON
22	T MUTE	O	Tuner mute signal L : ON
23	STREO	I	Tuner stereo signal detection L : STEREO DETECTION
24	SD	I	Tuning signal detection L : SD DETECTION
25	PLL DO	I	PLL IF count data
26	PLL CE	O	Chip enable for PLL IC
27	ATT	O	Attenuator control (RDS) H : ON
28	S LEVEL	I	Signal level H : ON
29	A VDD		A/D power supply (+5V)
30	A VREF		A/D reference voltage (+5V)
31	VENC B	I	Volume encoder input B
32	XT2		Unused (open)
33	VSS		U-com power supply
34,35	X1,X2		4.19MHz oscillator
36	VENC A	I	Volume encoder input A
37	SDA	O	Electric volume IC control data
38	SCL	I	Electric volume IC control clock
39	SENC B	I	Selector encoder input B
40	SENC A	I	Selector encoder input A
41	S DATA	I/O	8/16 bit system data
42	SBUSY	I/O	8/16 bit system clock H : BUSY L : READY
43	RESET	I	RDS u-com(UPD78044AGF162) reset signal L : RESET ON
44	CLOCK	I	RDS u-com(UPD78044AGF162) clock
45	DATA	I	RDS u-com(UPD78044AGF162) data
46	START	I	RDS data receiving start signal(UPD780AGF162) L : RECEIVING START
47	REMOCON	I	Remote control signal
48	IC		Connection VSS
49	POWER LED	O	Power LED L : ON
50	TYPE 2	I	Model choice 2

KR-A2080/A3080/A4080/A5080

CIRCUIT DESCRIPTION

1-9. Function initial setting

① POWER OFF (KR-A2080 : POWER ON)

② AMP system

- SELECTOR TUNER
- TAPE 1/MD TAPE 1
- VIDEO/LD VIDEO
- SPEAKER A ON
- SPEAKER B OFF
- TAPE 2 OFF
- VOLUME LEVEL 7
- AUDIO ADJUSTMENT MODE BALANCE
- BALANCE CENTER
- BASS/TREBLE 0dB
- SRS 3D OFF

③ TUNER system

- BAND FM
- FREQUENCY Lower limit of FM (87.5 MHz)
- TUNING MODE AUTO (AUTO TUNING)
- P. CH DISPLAY -- Ch

④ TEST PRESET FREQUENCY

Channel	BAND	K1 TYPE	BAND	K2 TYPE	BAND	E TYPE
01ch	FM	87.50MHz	FM	87.50MHz	FM	87.50MHz
02ch	FM	98.00MHz	FM	98.00MHz	FM	98.00MHz
03ch	FM	108.00MHz	FM	108.00MHz	FM	108.00MHz
04ch	AM	630kHz	AM	630kHz	AM	630kHz
05ch	AM	1000kHz	AM	1000kHz	AM	999kHz
06ch	AM	1440kHz	AM	1440kHz	AM	1440kHz
07ch	FM	87.50MHz	FM	87.50MHz	FM	87.50MHz
08ch	FM	87.50MHz	FM	87.50MHz	FM	87.50MHz
09ch	FM	87.50MHz	FM	87.50MHz	FM	87.50MHz
10ch	FM	89.10MHz	FM	89.10MHz	FM	89.10MHz
11ch	FM	90.00MHz	FM	90.00MHz	FM	90.00MHz
12ch	FM	97.50MHz	FM	97.50MHz	FM	97.50MHz
13ch	FM	98.50MHz	FM	98.50MHz	FM	98.50MHz
14ch	FM	106.00MHz	FM	106.00MHz	FM	106.00MHz
15ch	AM	530kHz	AM	530kHz	AM	531kHz
16ch	AM	990kHz	AM	990kHz	AM	990kHz
17ch	AM	1700kHz	AM	1610kHz	AM	1602kHz
18ch	FM	87.50 MHz	FM	87.50MHz	FM	87.50MHz
19ch	FM	87.50MHz	FM	87.50MHz	FM	87.50MHz
20ch	FM	87.50MHz	FM	87.50MHz	FM	87.50MHz

The initial setting is performed in a following event:

1. When backup memory data is destroyed when reset is applied to the microprocessor.
2. While pressing the MEMORY key, then turn on power and turn off power.

1-10. Contents of backup data to be held

--- AMP ---

- POWER STANDBY ON/OFF
- SELECTOR mode
- TAPE 1/MD condition
- VIDEO/LD condition
- TAPE 2 ON/OFF
- SPEAKER A RELAY ON/OFF
- SPEAKER B RELAY ON/OFF
- VOLUME LEVEL
- AUDIO LEVEL mode
- BALANCE LEVEL
- BASS LEVEL
- TREBLE LEVEL
- LOUDNESS ON/OFF
- SRS 3D ON/OFF

--- TUNER ---

- LAST BAND
- PRESET CHANNEL FREQUENCY
- LAST FREQUENCY (FM/AM)
- PRESET MEMORY (1ch ~ 40ch)
- AUTO/MANUAL mode

KR-A2080/A3080/A4080/A5080

CIRCUIT DESCRIPTION

2. TEST MODE

2-1. TEST MODE OF MAIN UNIT

(1) Setting the test mode

The main unit is put into the test mode when the AC power is turned ON while pressing the "TUNING DOWN" key. The following state is obtained when the test mode of the main unit is set.

- The power is turned ON automatically.
- All the fluorescent display indicators and LEDs light. (The all-illuminated state is cleared by pressing any main unit key.)
- The backup state except when the power is turned ON and OFF is initialized.

(2) Canceling the test mode

Turn OFF the AC power.

(3) Tuner functions

- Preset channel call function
 - 1) Calls channels 1 to 9 (keys 1 to 9) and channel 10 (key 0) when the 10 key is not operated.
 - 2) Calls channels 11 to 19 (keys 1 to 9) and channel 20 (key 0) when the +10 key is operated once.
 - 3) Calls channels 21 to 29 (keys 1 to 9) and channel 30 (key 0) when the +10 key is operated two times and calls channels 31 to 39 (keys 1 to 9) and channel 40 (key 0) when the +10 key is operated three times.
 - 4) Shifts to the operation obtained when the +10 key is not operated if it is operated four times.

- S level hexadecimal data display function (E,T type)

With the selector on TUNER, when the "PTY" key on the main unit is operated, the frequency display ceases and the S level is displayed in hexadecimal while the key is pressed. When "LOUDNESS" is operated, the display is switched to restore the normal display.

- Mute signal output

No Selector MUTE (MUTE 1) control regulation is done whatever.

- RDS attenuator (E,T type)

With the selector on TUNER, when the "SP A" key on the main unit is operated, the SP A display is erased and ATT is on. If the "SP A" on the main unit is operated again after that, SP A is displayed and ATT is switched off. The SP A operation and ATT operation work together and are combined with switching the ATT display on and off.

* Under the ATT on/off relationship, ATT can not be entered in an AF search in test mode.

The ATT operation is done from ATT off.

If SP A was turned off with the selector on something other than TUNER, it will come on when TUNER is selected.

(4) AMP function

The original function of each key is executed when the SELECTOR mode is set to TUNER. The test mode operation is not performed in this case.

- Impedance 4/8 selection

No impedance 4/8 display appears in the normal state. Therefore, the SPEAKERS lamp of the fluorescent display indicator is turned ON and OFF in the test mode.

The SPEAKERS lamp is turned on when the impedance is 4. The SPEAKERS lamp is turned off when the impedance is 8.

- One touch max, mid, min setting for VOLUME

The variation of audio level and surround level can be operated by turning the Multi-Level up or down and, if the selector is on something other than TUNER, max, mid, min settings can be made with the number keys.

(1) Max is number key "3" : LEVEL 75

(2) Mid is number key "2" : LEVEL 7

(3) Min is number key "1" : LEVEL 0

- One touch settings for Audio Level Mode

The variation of audio level mode items can be set with respective keys and, if the selector is on something other than TUNER, direct settings can be made with the number keys.

(1) Balance is number key " 4 "

(2) Bass is number key " 5 "

(3) Treble is number key " 6 "

- MUTE signal output

Sets the analog muting to OFF at all times. No control is performed in this case. Sets the analog muting to ON in the same way as during normal operation when the front volume is set to the minimum value ($-\infty$ dB).

- MUTE Operation

Mute operation is toggled on and off by pressing the "AUTO/MANUAL" key.

KR-A2080/A3080/A4080/A5080

ADJUSTMENT

AM . Section : If alignment point is "-", Confirm the value.
If not, replace the front end pack.

No.	ITEM	INPUT SETTINGS	OUTPUT SETTINGS	TUNER SETTINGS	ALIGNMENT POINTS	ALIGN FOR	FIG.
FM SECTION		SELECTOR : FM					
1	DISCRIMINATOR	(A) 98.0MHz 1kHz , ±75kHz dev. 60dBμ (ANT. input)	Connect a DC voltmeter across CN2 (X05)	MONO 98.0MHz	L5 (X05)	0V	(a)
AUDIO SECTION							
<1>	IDLE CURRENT	-	Connect a DC voltmeter between TP1 and 2(L) TP3 and 4(R) (X09)	Volume : 0	VR1 (L) VR 2 (R) (X09)	(KR-A2080/A3080) 13mV (KR-A4080/A5080) 20mV	

(a)

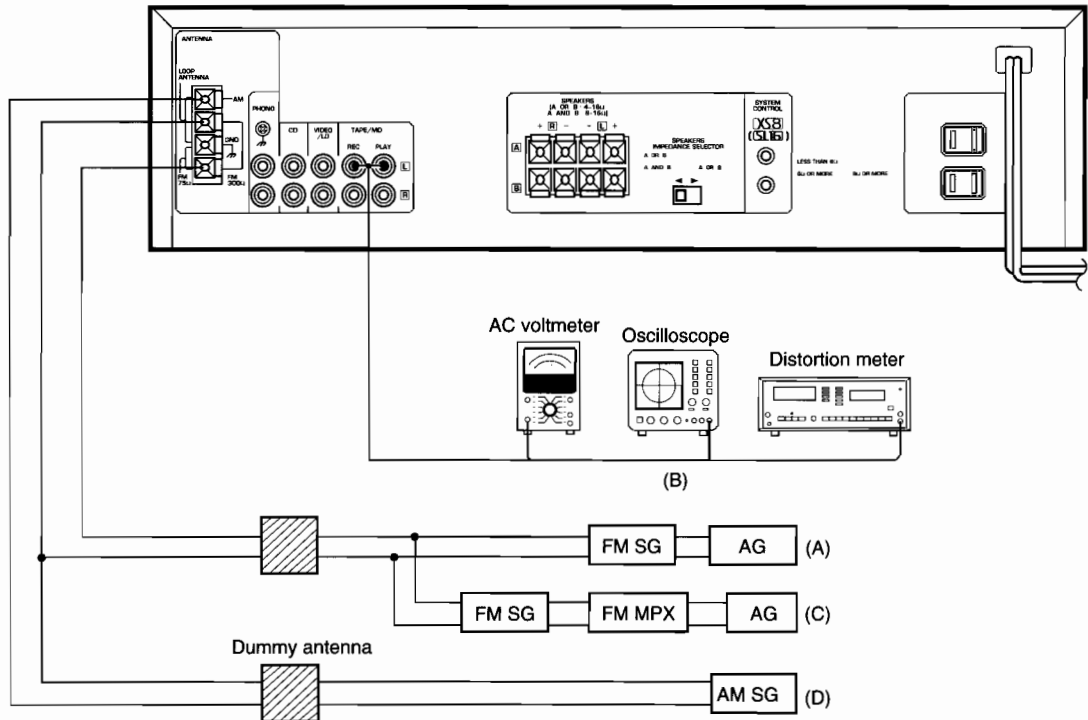

KR-A2080/A3080/A4080/A5080

WIRING DIAGRAM

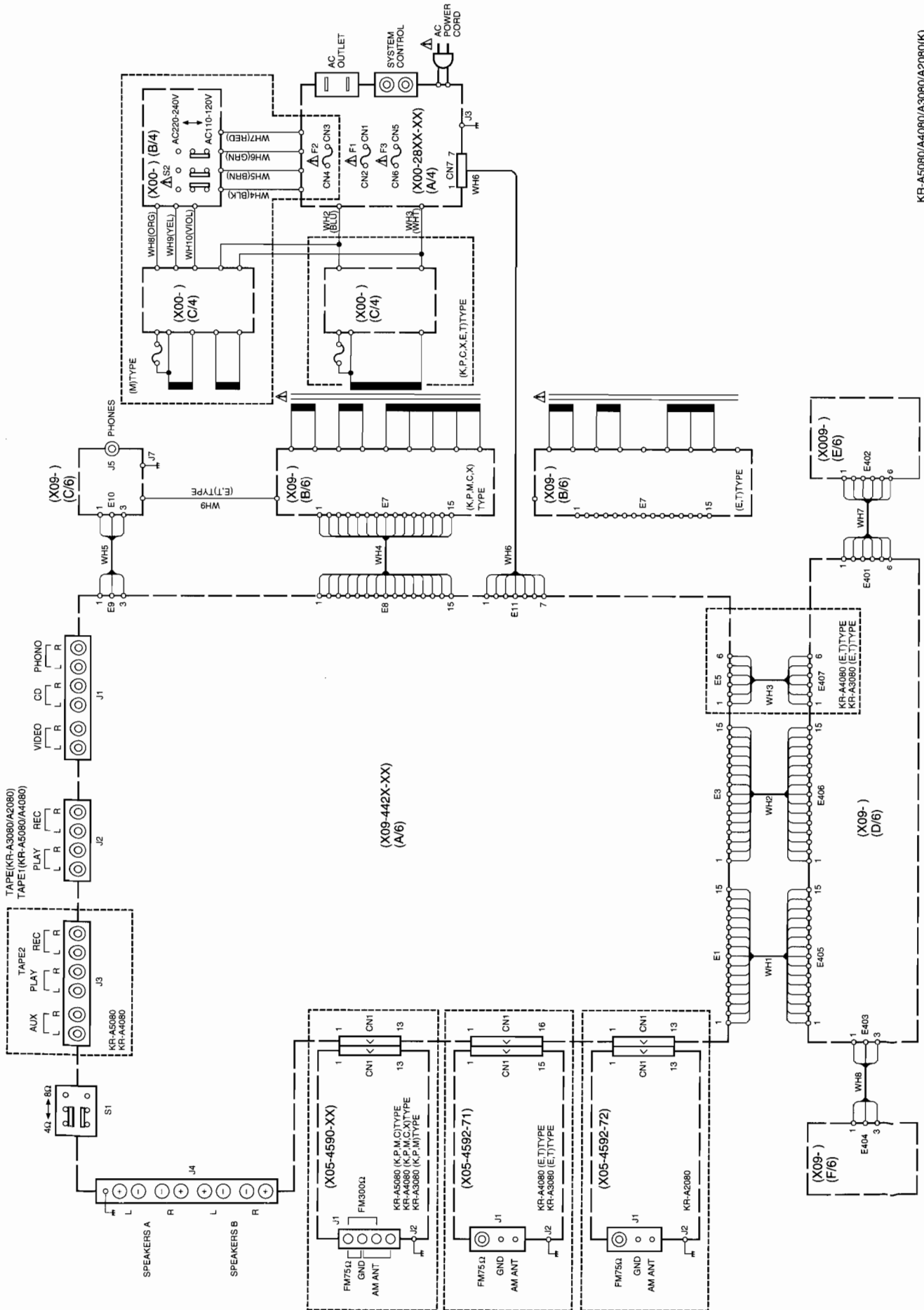

KR-A5080/A4080/A3080/A2080(K)

PC BOARD (Component side view)

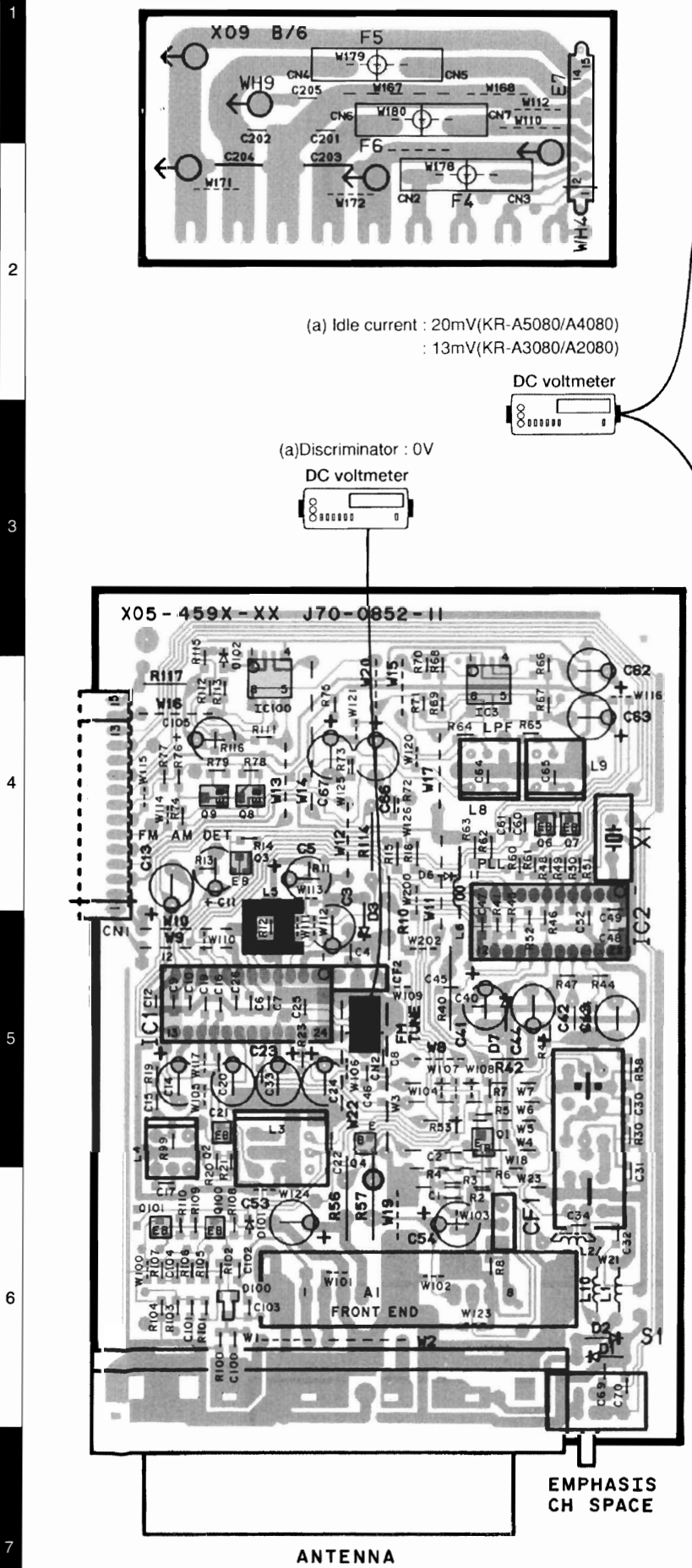

(a) Idle current : 20mV(KR-A5080/A4080)
: 13mV(KR-A3080/A2080)

DC voltmeter

(a)Discriminator : 0V

DC voltmeter

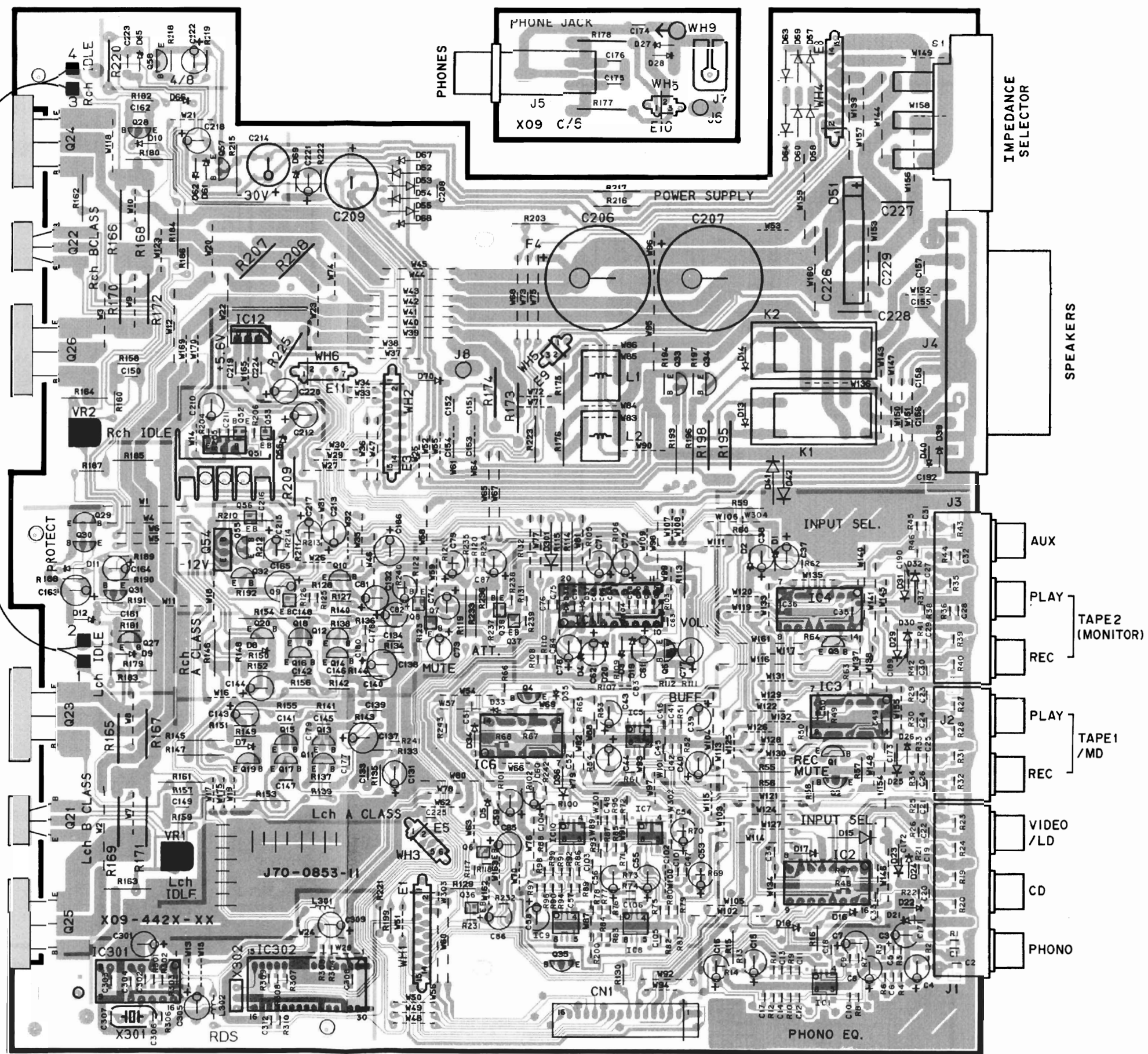

Refer to the schematic diagram for the values of resistors and capacitors.

PC BOARD (Component side view)

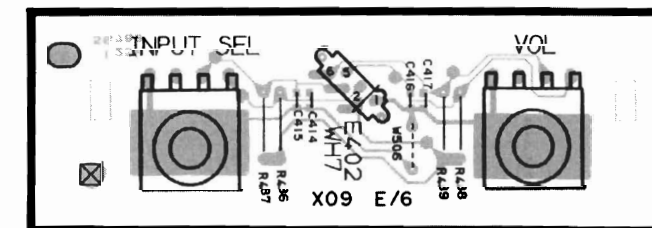
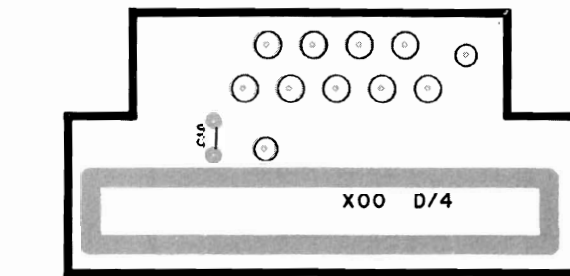
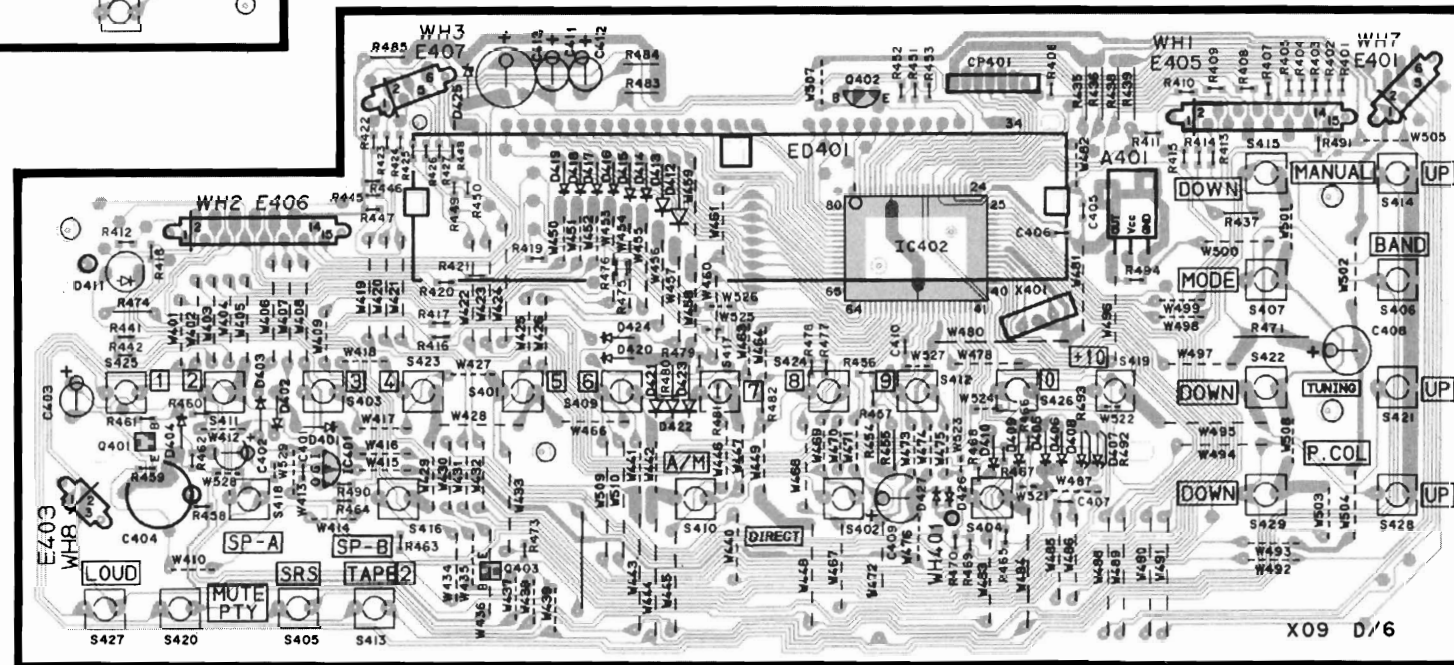
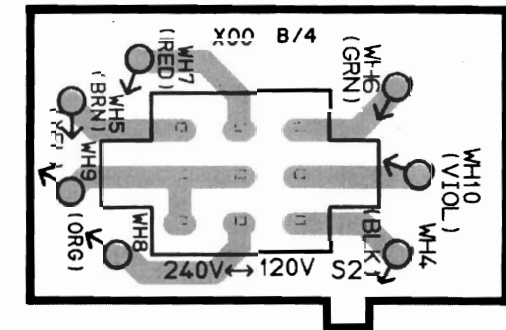
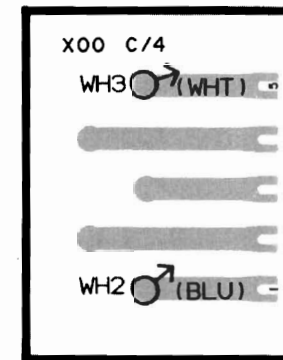
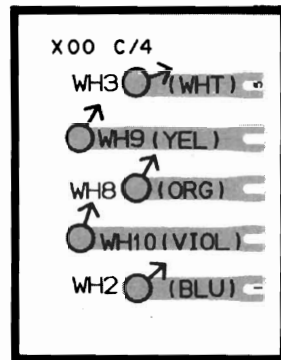
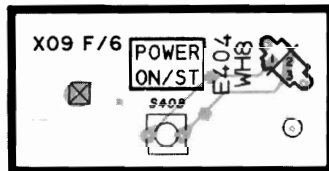
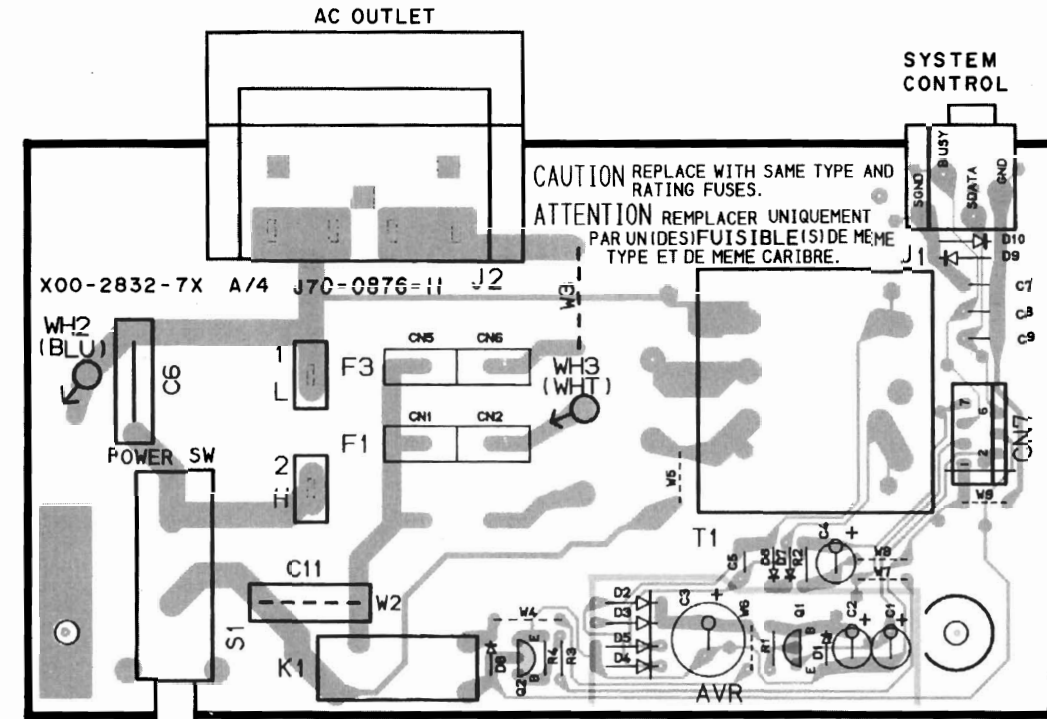
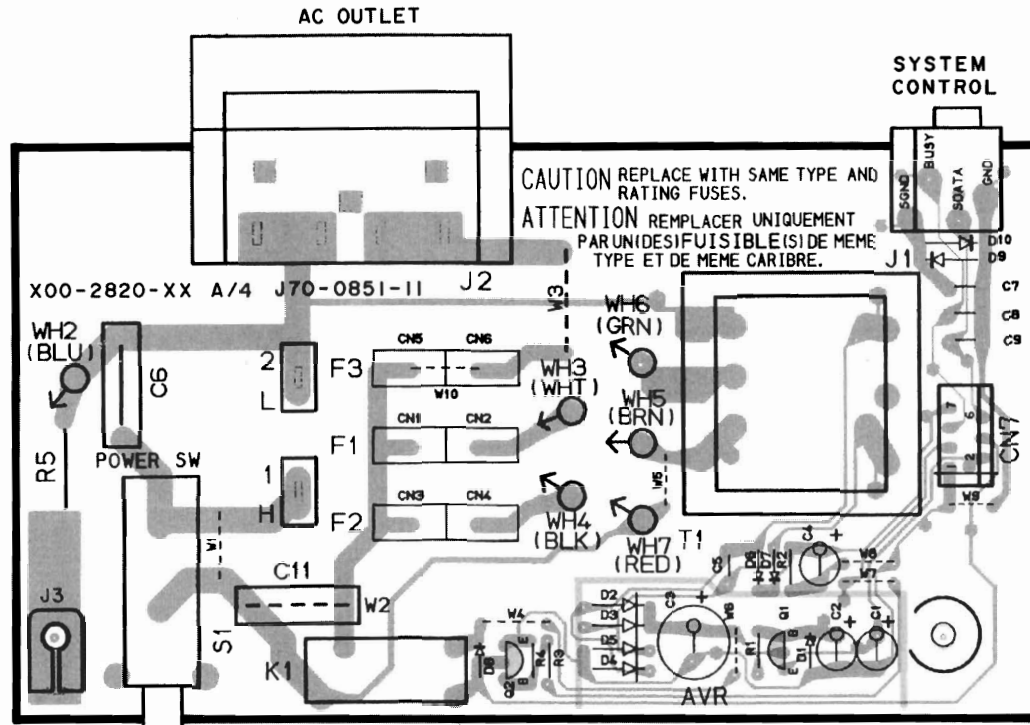

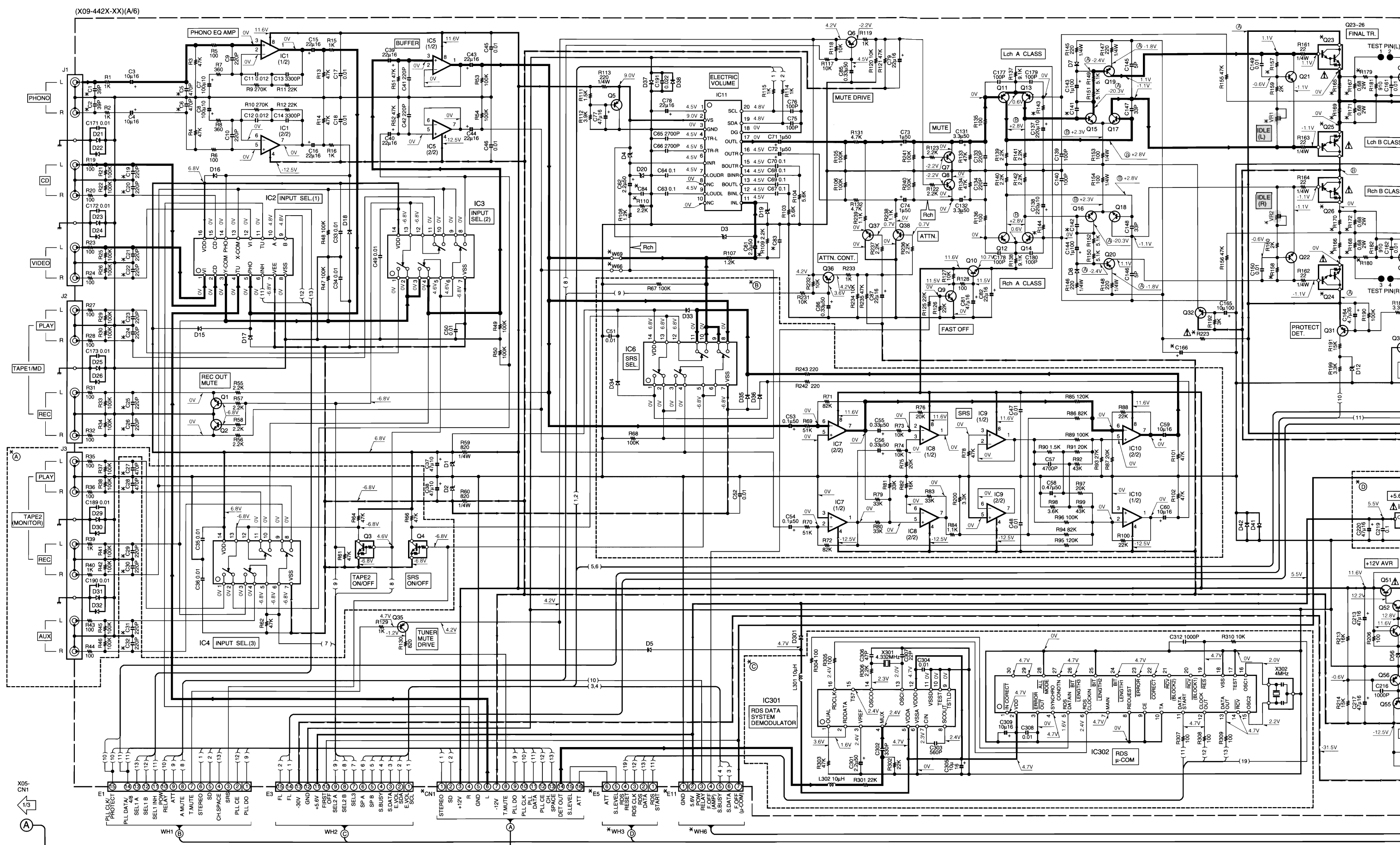

CAUTION: For continued safety, replace safety critical components only with manufacturer's recommended parts (refer to parts list). Δ indicates safety critical components. For continued protection against risk of fire, replace only with same type and rating fuse(s). To reduce the risk of electric shock, leakage-current or resistance measurements shall be carried out (exposed parts are acceptably insulated from the supply circuit) before the appliance is returned to the customer.

The DC voltage is an actual reading measured with a high impedance type voltmeter as the AM/FM signal generator is specified to the conditions as shown in the list below. The measurement value may vary depending on the measuring instruments used or on the product. The value shown in () is actual reading measured in the AM mode.

MODE
FM
AM

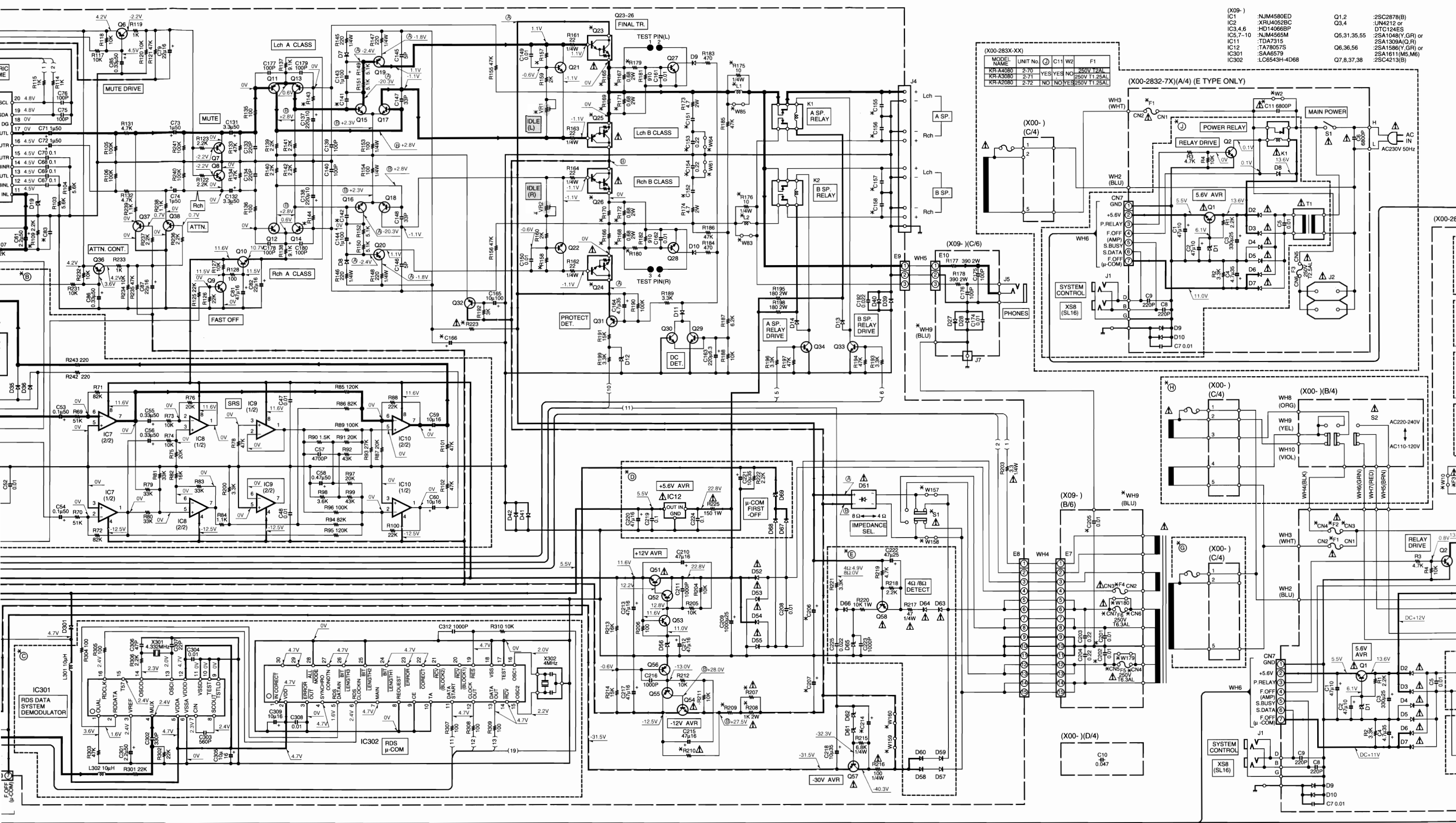

tical components only with manufacturer's y critical components. For continued protection ig fuse(s). To reduce the risk of electric shock, ied out (exposed parts are acceptably insulated the customer.

The DC voltage is an actual reading measured with a high impedance type voltmeter as the AM/FM signal generator is specified to the conditions as shown in the list below. The measurement value may vary depending on the measuring instruments used or on the product. The value shown in () is actual reading measured in the AM mode.

MODE	CARRIER	MODULATION		ANT INPUT
		FREQUENCY	DEVIATION	
FM	98MHz	1kHz	STEREO 67.5kHz 7.5kHz(Pilot)	60dB
AM	1000(999)kHz	400Hz	MONO 30% MOD	60dB

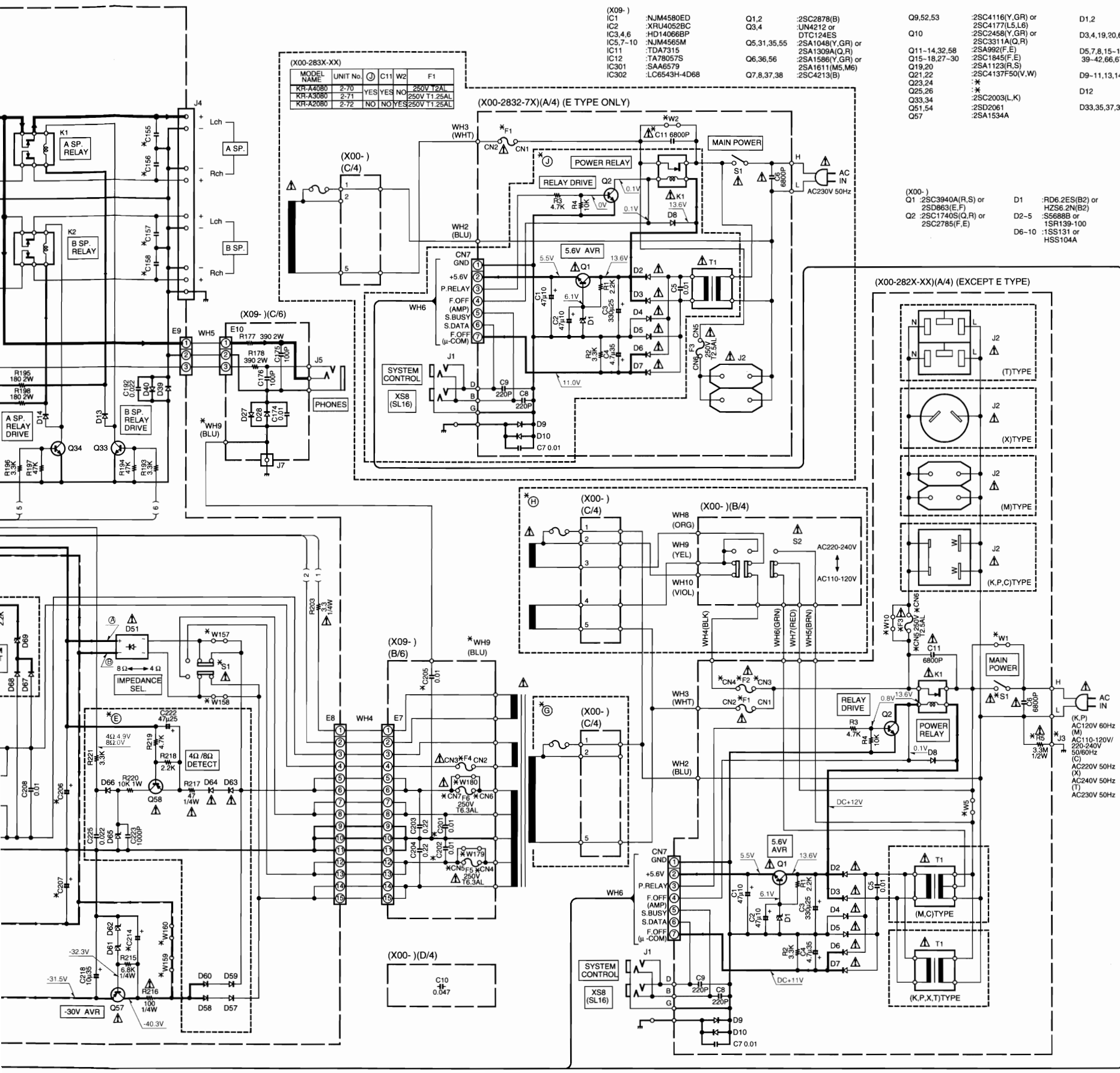

Component Lists:

(X09-)

IC1	:NJM4580ED	Q1,2	:2SC2878(B)	Q9,52,53	:2SC4116(Y,GR) or 2SC4177(L,S,L6)	D1,2	:RD6.8ES(B2) or HZ56.8N(B2)	D51	:D5SBA20F03
IC2	:XRU4052BC	Q3,4	:UN4212 or DT1C124ES	Q10	:2SC2458(V,GR) or 2SC3311A(Q,R)	D3,4,19,20,69	:RD6.2ES(B2) or HZ58.2N(B2)	D52-55,57-60,63,64	:S5688B or 1SR139-100
IC3,4,6	:HD140686P	Q5,31,35,55	:2SA1048(Y,GR) or 2SA992(F,E)	Q11-14,32,58	:2SA992(F,E)	D5,7,8,15-18,21-32,34,36,39-42,66,67,68,301	:1SS133 or HSS104	D56	:RD11ES(B2) or HZ511N(B2)
IC11	:TA7315	Q6,36,56	:2SA1586(Y,GR) or 2SA1811(M5,M6)	Q15-18,27-30	:2SC1845(F,E)	Q19,20	:1SS131 or HSS104A	D61,62	:RD16ES(B2) or HZ516N(B2)
IC12	:TA78057S	Q7,8,37,38	:2SC4213(B)	Q21,22	:2SA1123(R,S)	Q23,24	:RD5.1ES(B2) or HZ55.1N(B2)	D65	:RD5.6ES(B) or HZ55.6N(B)
IC301	:SAA6579			Q25,26	:2SC2003(L,K)	Q33,34			
IC302	:LC6543H-4D68			Q51,54	:2SD2061	Q57			

(X00-)

Q1	:2SC3940A(R,S) or 2SD863(E,F)	D1	:RD6.2ES(B2) or HZ56.8N(B2)
Q2	:2SC1740S(Q,R) or 2SC2785(F,E)	D2-5	:S5688B or 1SR139-100
		D6-10	:1SS131 or HSS104A

Table 1: KR-A5080 (X00-282X-XX)

DESTINATION	UNIT No.	J2	(A)	(B)	(C)	(D)	(E)	R5	J3	CN3,4	CN5,6	F1	F2	F3	T1	S1	W1	W5	W10
K	0-10	E03-0148-05	YES	NO	YES	YES	NO	NO	NO	NO	NO	125V 6A	NO	NO	L07-2127-05	NO	YES	YES	YES
M	0-21	E03-0149-05	NO	YES	NO	NO	YES	NO	NO	YES	NO	250V T2.5AL	250V T2.5AL	NO	L07-2128-05	YES	NO	NO	YES
C	3-01	E03-0330-05	YES	NO	NO	NO	NO	NO	NO	NO	NO	250V T2.5AL	NO	NO	L07-2128-05	YES	NO	YES	YES

Table 2: KR-A4080 (X00-282X-XX)

DESTINATION	UNIT No.	J2	(A)	(B)	(C)	(D)	(E)	R5	J3	CN3,4	CN5,6	F1	F2	F3	T1	S1	W1	W5	W10
K	0-11	E03-0148-05	YES	NO	YES	YES	NO	NO	NO	NO	NO	125V 6A	NO	NO	L07-2127-05	NO	YES	YES	YES
M	0-22	E03-0149-05	NO	YES	NO	NO	YES	NO	NO	YES	NO	250V T2.5AL	250V T2.5AL	NO	L07-2128-05	YES	NO	NO	YES
C	3-02	E03-0330-05	YES	NO	NO	NO	NO	NO	NO	NO	NO	250V T2.5AL	NO	NO	L07-2128-05	YES	NO	YES	YES
X	0-71	E03-0325-05	YES	NO	NO	NO	NO	NO	NO	NO	NO	250V T2.5AL	NO	NO	L07-2129-05	YES	NO	YES	YES
T	0-51	E03-0310-05	YES	NO	NO	NO	NO	NO	NO	NO	YES	250V T2.5AL	NO	YES	L07-2129-05	YES	NO	YES	NO

Table 3: KR-A3080 (X00-282X-XX)

DESTINATION	UNIT No.	J2	(A)	(B)	(C)	(D)	(E)	R5	J3	CN3,4	CN5,6	F1	F2	F3	T1	S1	W1	W5	W10
K	0-10	E03-0148-05	YES	NO	YES	YES	NO	NO	NO	NO	NO	125V 6A	NO	NO	L07-2127-05	NO	YES	YES	YES
M	0-23	E03-0149-05	NO	YES	NO	NO	YES	NO	NO	YES	NO	250V T1.25AL	250V T1.25AL	NO	L07-2128-05	YES	NO	NO	YES
T	0-52	E03-0310-05	YES	NO	NO	NO	NO	NO	NO	NO	YES	250V T1.25AL	NO	YES	L07-2129-05	YES	NO	YES	NO

Table 4: KR-A5080 (X09-442X-XX)

DESTINATION	UNIT No.	(A)	(B)	(C)	(D)	(E)	C1,2,5,6,19-32, 153,154,205	C83,84	C141, 142	C151, 152	C155-158	C166	C201,202	C206, 207	C214	R109,110,167,168, 171,172,208	R143, 144	R157, 158	R165,166, 169,170	R175, 176	R179, 180
K	0-10	YES	NO	NO	NO	NO	1800P	82P	0.1	1000P	10u/100	YES	6800u/71	47u/100	YES	180	6.8K	0.68 2W	NO	NO	
M	0-21	NO	YES	NO	NO	NO	2SD2222	2S81470	YES	NO	YES	NO	NO	NO	NO	YES	13PIN	2.2K	250V 1.25A	NO	NO
C	0-21	YES	NO	NO	NO	NO	1800P	82P	0.1	1000P	10u/100	YES	6800u/71	47u/100	YES	180	6.8K	0.68 2W	NO	NO	

Table 5: KR-A4080 (X09-442X-XX)

DESTINATION	UNIT No.	(A)	(B)	(C)	(D)	(E)	C1,2,5,6,19-32, 153,154,205	C83,84	C141, 142	C151, 152	C155-158	C166	C201,202	C206, 207	C214	R109,110,167,168, 171,172,208	R143, 144	R157, 158	R165,166, 169,170	R175, 176	R179, 180
K	0-11	YES	NO	NO	YES	NO	1800P	100P	0.1	1000P	10u/100	YES	5600u/63	220u/63	YES	200	6.2K	0.68 2W	NO	6.8K 1/4W	
M	0-22	NO	YES	NO	NO	NO	2SD2222	2S81470	YES	NO	YES	NO	NO	NO	NO	YES	13PIN	2.2K	250V T800MAL	YES	NO
X	0-71	YES	NO	NO	NO	NO	1800P	470P	0.22	0.022	0.47u/100	NO	5600u/56	NO	YES	240	6.8K	0.68 2W	YES	6.8K 1/4W	
T	2-71	YES	YES	NO	NO	NO	1800P	470P	0.22	0.022	0.47u/100	NO	5600u/56	NO	YES	240	6.8K	0.68 2W	YES	6.8K 1/4W	

Table 6: KR-A3080 (X09-442X-XX)

DESTINATION	UNIT No.	(A)	(B)	(C)	(D)	(E)	C1,2,5,6,19-32, 153,154,205	C27-32	C83,84	C141, 142	C151, 152	C155-158	C166	C201, 202	C206, 207	C214	R109,110,167,168, 171,172,208	R143, 144	R157, 158	R165,166, 169,170	R175, 176	R179, 180
K	0-11	NO	NO	YES	NO	NO	1000P	100P	0.1	1000P	10u/100	YES	4700u/52	220u/63	NO	NO	NO	390	6.8K	0.22 2W	NO	NO
M	0-23	NO	YES	NO	NO	NO	1000P	470P	0.22	8200P	10u/100	NO	4700u/52	NO	NO	NO	YES	1K	250V T800MAL	YES	NO	
T	2-71	NO	YES	NO	NO	NO	1000P	470P	0.22	8200P	10u/100	NO	4700u/52	NO	NO	NO	YES	1K	250V T800MAL	YES	NO	

Table 7: KR-A2080 (X09-4422-73)

DESTINATION	UNIT No.	(A)	(B)	(C)	(D)	(E)	C1,2,5,6,19-32, 153,154,205	C27-32,201, 202,214	C83,84	C141, 142	C151, 152	C155-158	C166	C201, 202	C206, 207	C214	R109,110,167,168, 171,172,208,210	R143, 144	R157, 158	R165,166, 169,170	R175, 176	R179, 180
E	2-73	NO	YES	YES	YES	NO	1000P	470P	0.22	8200P	10u/100	NO	4700u/52	NO	NO	NO	NO	560	6.8K	0.22 2W	YES	3.9K 1/4W

Table 8: KR-A2080 (X09-4422-73)

DESTINATION	UNIT No.	(A)	(B)	(C)	(D)	(E)	C1,2,5,6,19-32, 153,154,205	C27-32,201, 202,214	C83,84	C141, 142	C151, 152	C155-158	C166	C201, 202	C206, 207	C214	R109,110,167,168, 171,172,208,210	R143, 144	R157, 158	R165,166, 169,170	R175, 176	R179, 180
E	2-73	NO	YES	YES	YES	NO	1000P	470P	0.22	8200P	10u/100	NO	4700u/52	NO	NO	NO	NO	560	6.8K	0.22 2W	YES	3.9K 1/4W

Table 9: KR-A2080/A3080/A4080/A5080(K)(2/3)

DESTINATION	UNIT No.	(A)	(B)	(C)	(D)	(E)	C1,2,5,6,19-32, 153,154,205	C27-32,201, 202,214	C83,84	C141, 142	C151, 152	C155-158	C166	C201, 202	C206, 207	C214	R109,110,167,168, 171,172,208,210	R143, 144	R157, 158	R165,166, 169,170	R175, 176	R179, 180
E	2-73	NO	YES	YES	YES	NO	1000P	470P	0.22	8200P	10u/100	NO	4700u/52	NO	NO	NO	NO	560	6.8K	0.22 2W	YES	3.9K 1/4W

Table 10: DESTINATION

COUNTRY	ABB.
U.S.A.	K
CANADA	P
GENERAL MARKET	M
CHINA	C
AUSTRALIA	X
U.K.	T
EUROPE	E



Table 11: MODULATION

FREQUENCY	MODULATION	ANT INPUT
1kHz	STEREO 67.5kHz 7.5kHz(Pilot)	60dB
400Hz	MONO 30% MOD	60dB

Y05-3232-72

KR-A2080/A3080/A4080/A5080

KENWOOD



(X09-442X-XX) (D/6)

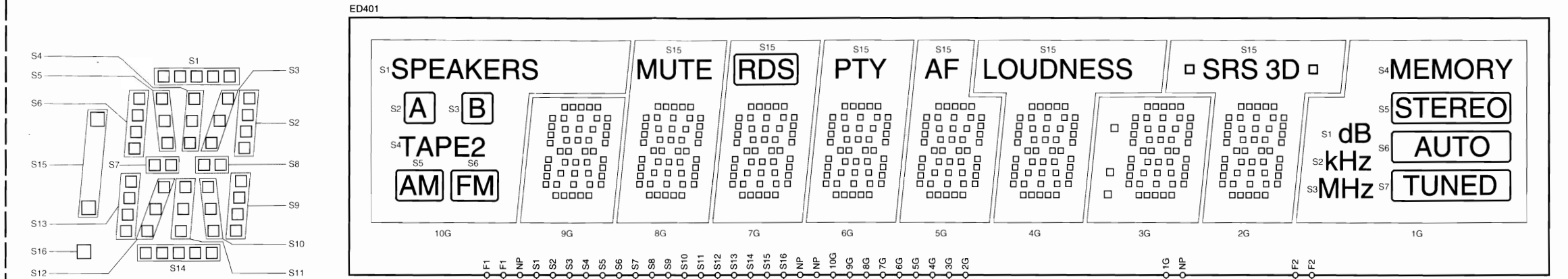

KR-A5080 (X09-442X-XX)

DESTINATION	UNIT No.	(A)	(B)	(C)	(D)	(E)	IC402	Q403	D420, 424	D421, 422	S405, 413	R454, 455	R456, 457, 491-494	R472, 473
K	0-10			YES			μPD78043AGF040	NO	NO	NO	NO	YES	YES	NO
P				NO				NO	NO	NO	NO	NO	NO	NO
M	0-21	YES		NO				YES	YES	NO	NO	NO	NO	YES
C				NO				NO	NO	NO	NO	NO	NO	NO

KR-A4080 (X09-442X-XX)

DESTINATION	UNIT No.	(A)	(B)	(C)	(D)	(E)	IC402	Q403	D420	D421	D422	D424	S405, 413	R454, 455, 492-494	R456, 457, 491-494	R472, 473	R491
K	0-11			YES			μPD78043AGF040	NO	NO	NO	NO	NO	NO	NO	NO	NO	NO
P				NO				NO	NO	NO	NO	NO	NO	NO	NO	NO	NO
M	0-22	YES		NO				YES	NO	NO	NO	NO	NO	NO	NO	NO	NO
X	0-71			NO				NO	YES	YES	NO	NO	NO	NO	NO	NO	NO
T				NO				NO	NO	NO	NO	NO	NO	NO	NO	NO	NO
E	2-71			YES			μPD78044AGF162	NO	NO	NO	NO	NO	NO	NO	NO	NO	YES

KR-A3080 (X09-442X-XX)

DESTINATION	UNIT No.	(A)	(B)	(C)	(D)	(E)	IC402	Q403	D420	D421	D422	D424	S405, 413	R454, 455, 492-494	R456, 457, 491-494	R472, 473	R491
K	0-12			YES			μPD78043AGF040	NO	NO	NO	NO	NO	NO	NO	NO	NO	NO
P				NO				NO	NO	NO	NO	NO	NO	NO	NO	NO	NO
M	0-23	YES		NO				YES	NO	NO	NO	NO	NO	NO	NO	NO	NO
X	0-71			NO				NO	YES	YES	NO	NO	NO	NO	NO	NO	NO
T				NO				NO	NO	NO	NO	NO	NO	NO	NO	NO	NO
E	2-72			YES			μPD78044AGF162	NO	NO	NO	NO	NO	NO	NO	NO	NO	YES

KR-A2080 (X09-442X-XX)

DESTINATION	UNIT No.	(A)	(B)	(C)	(D)	(E)	IC402	Q403	D420, 421	D422, 424	S405, 413	R454, 455, 472, 473	R456, 457, 491-494
E	2-73			NO			μPD78043AGF040	NO	YES	NO	NO	NO	YES

DESTINATION	COUNTRY	ABB.
U.S.A.		K
CANADA		P
GENERAL MARKET		M
CHINA		C
AUSTRALIA		X
U.K.		T
EUROPE		E

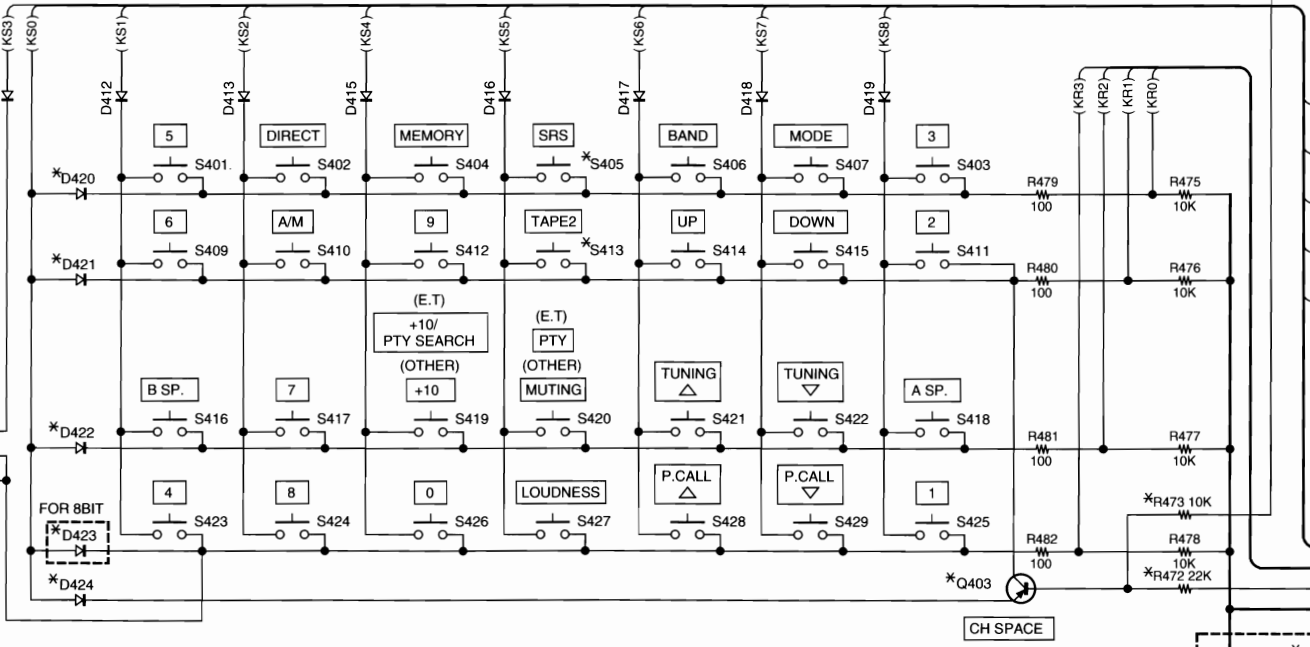
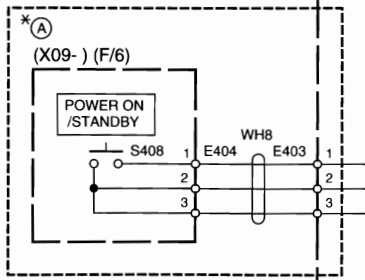
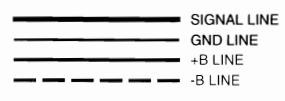

- (X09-) (D/6)
- IC401 : S-806D-Z
 - IC402 : *
 - Q401 : 2SC4116(Y,GR) or 2SC4177(L5,L6)
 - Q402 : 2SC2458(Y,GR) or 2SC3311A(Q,R)
 - Q403 : 2SA1586(Y,GR) or 2SA1611(M5,M6)
 - D401-410 : 1SS133 or HSS104
 - D412-422,424 : 1SS131 or HSS104A
 - D411 : B30-1291-05
 - D425 : RD5.6ES(B) or HZS5.6N(B)
 - D426,427 : MA111
 - ED401 : FIP10BM6R
 - A401 : W02-2551-05

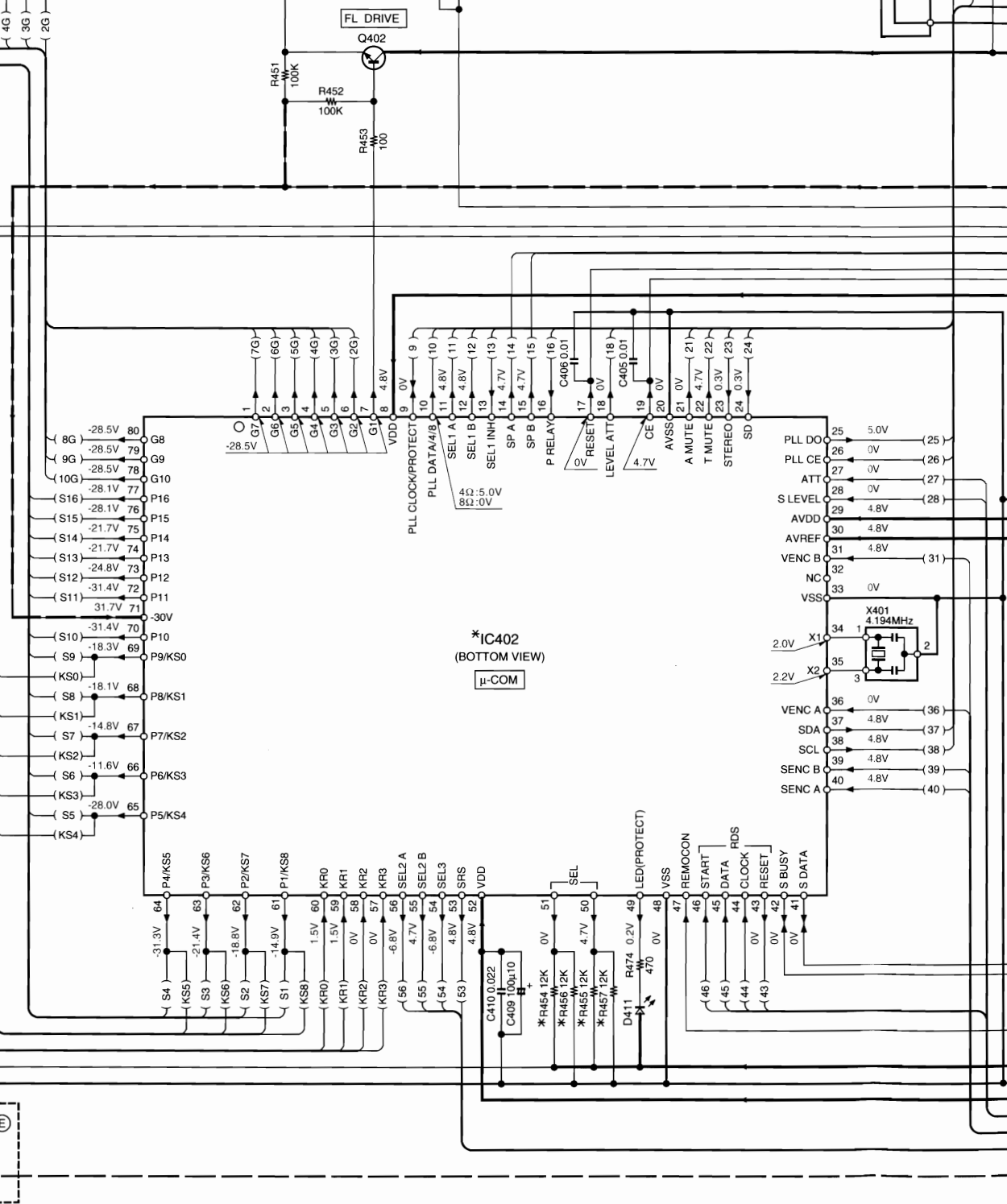

*IC402 (BOTTOM VIEW) μ-COM

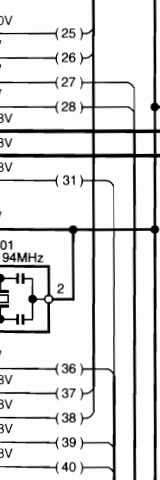
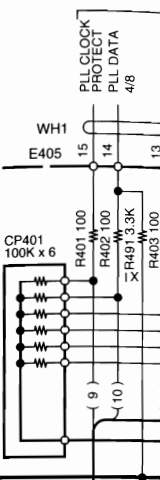

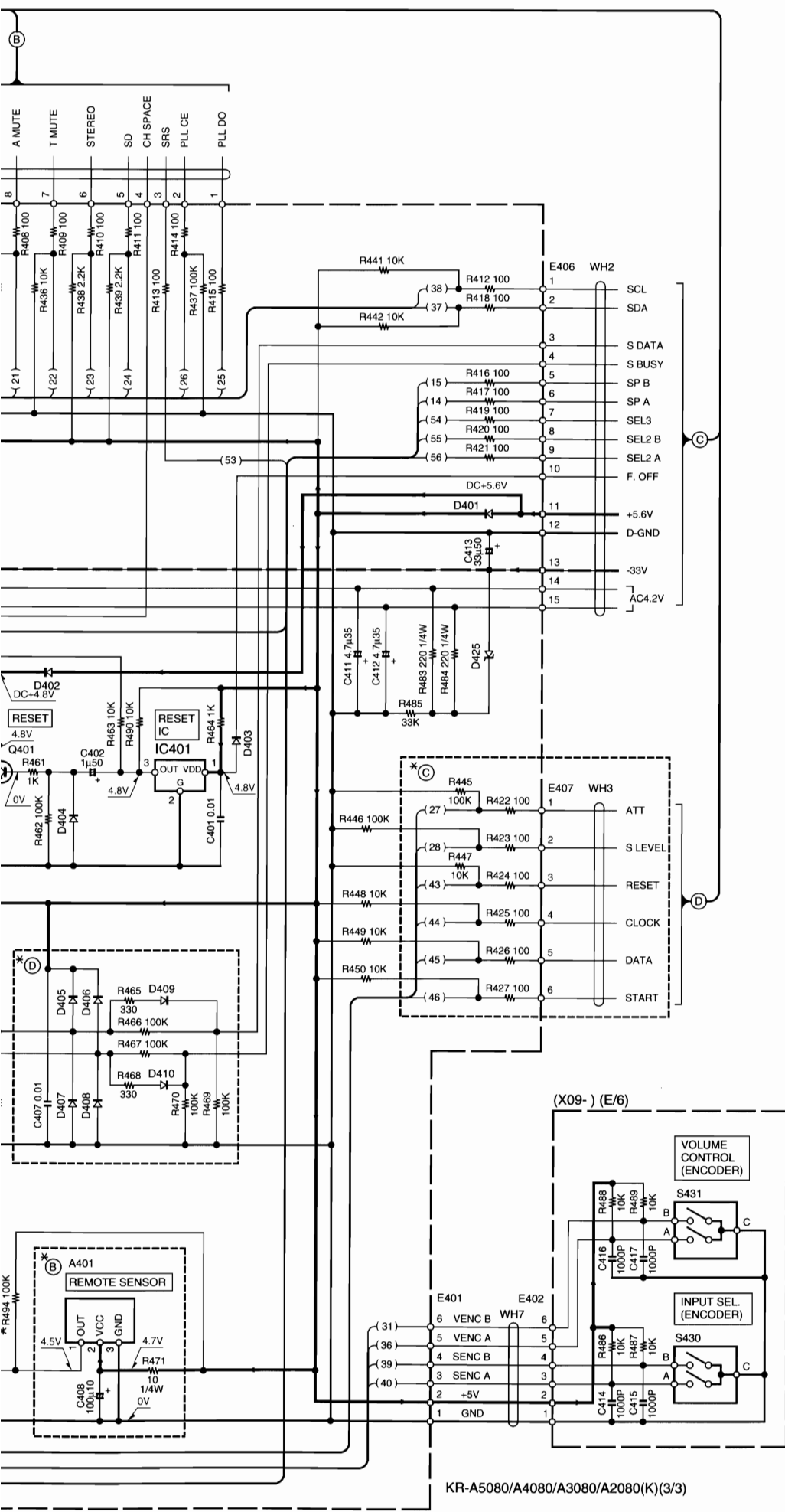

KR-A5080/A4080/A3080/A2080(K)(3/3)

CAUTION: For continued safety, replace safety critical components only with manufacturer's recommended parts (refer to parts list). Δ indicates safety critical components. For continued protection against risk of fire, replace only with same type and rating fuse(s). To reduce the risk of electric shock, leakage-current or resistance measurements shall be carried out (exposed parts are acceptably insulated from the supply circuit) before the appliance is returned to the customer.

The DC voltage is an actual reading measured with a high impedance type voltmeter as the AM/FM signal generator is specified to the conditions as shown in the list below. The measurement value may vary depending on the measuring instruments used or on the product. The value shown in () is actual reading measured in the AM mode.

MODE	CARRIER	MODULATION		ANT INPUT
		FREQUENCY	DEVIATION	
FM	98MHz	1kHz	STEREO 67.5kHz 7.5kHz(Pilot)	60dB
AM	1000(999)kHz	400Hz	MONO 30% MOD	60dB

- 2SA1123
2SA1534A
2SA992
2SC1845
2SC2003
- 2SC2878
2SC3940A
2SD863
- 2SB1624
2SD2493
- 2SC2785
- DTC124ES
2SA1048
2SC1740S
2SC2458
- 2SA1586
2SC2714
2SC4116
2SD1757K
- 2SB1470
2SC4137F50
2SD2222
- 2SD2061
- UN4212
2SA1309A
2SC3311A
- 2SB1560
2SD2390
- HD14066BP
- XRU4052BC
- TDA7315
- BA1450S
- SAA6579
- NJM4565M
NJM4580ED
- M5223FP
- LC72131
- UPD78043AGF040
UPD78044AGF16

KR-A2080/A3080/A4080/A5080 EXPLODED VIEW

KR-A2080/A3080/A4080/A5080

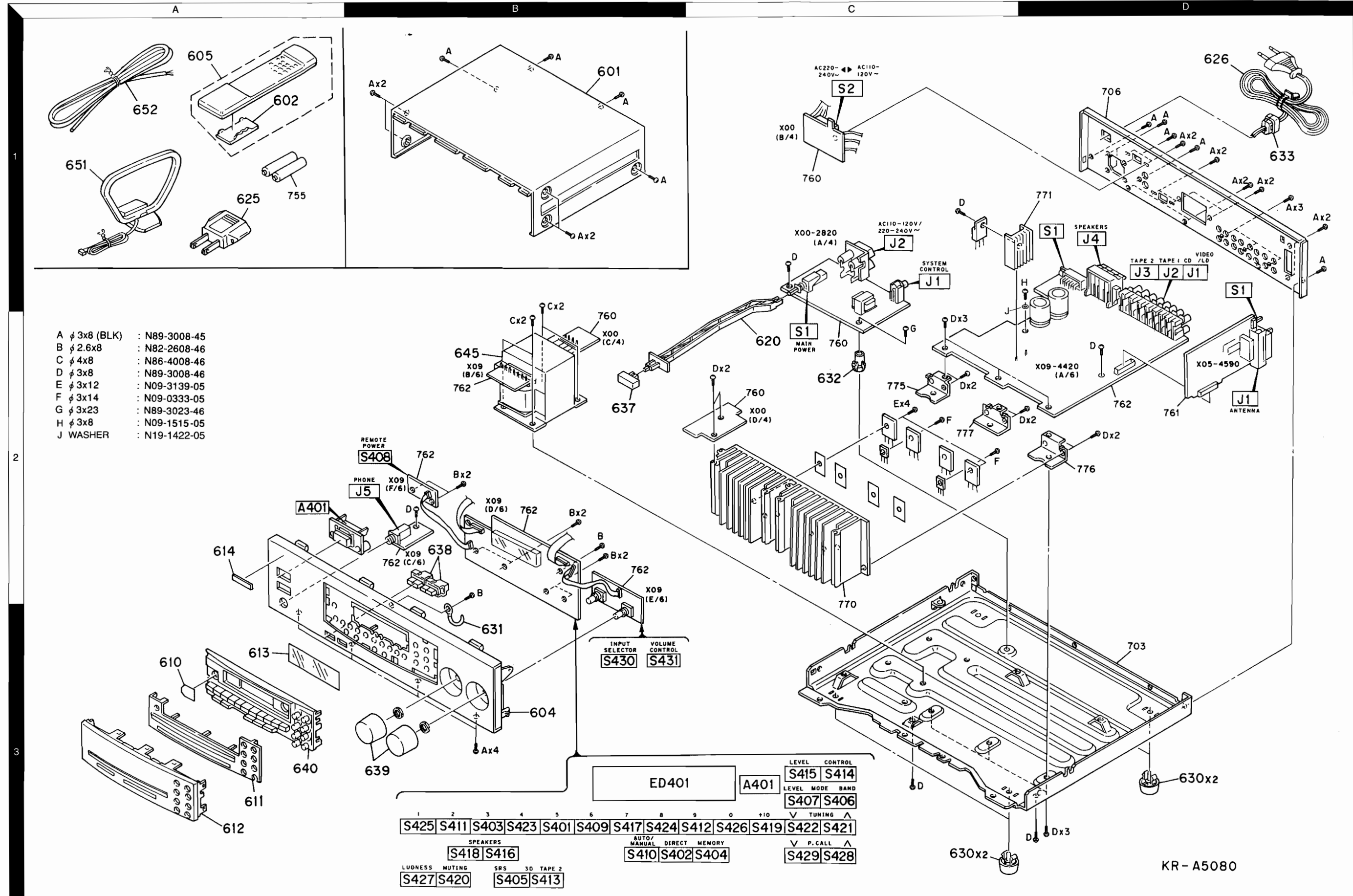

KR-A5080

Parts with the exploded numbers larger than 700 are not supplied.

* New Parts
Parts without **Parts No.** are not supplied.
Les articles non mentionnés dans le **Parts No.** ne sont pas fournis.
Teile ohne **Parts No.** werden nicht geliefert.

①

Ref. No	Add-ress	New Parts	Parts No.	Description	Desti-nation	Re-marks
KR-A4080/A5080						
601	1B		A01-3300-11	METALLIC CABINET		
602	1A		A09-0341-08	BATTERY COVER		
604	3B	*	A60-0874-01	PANEL	KP	5
604	3B	*	A60-0875-01	PANEL	MC	5
604	3B	*	A60-0876-01	PANEL	KP	4
604	3B	*	A60-0877-01	PANEL	MCX	4
604	3B	*	A60-0878-01	PANEL	TE	4
605	1A		A70-1044-05	REMOTE CONTROLLER ASSY KPMCX		
605	1A		A70-1045-05	REMOTE CONTROLLER ASSY TE		
610	3A		B03-2966-04	DRESSING PLATE		
611	3A		B07-2298-02	ESCUTCHEON		
612	3A	*	B10-2203-12	FRONT GLASS	KPMCX	
612	3A	*	B10-2235-12	FRONT GLASS	TE	
613	3A	*	B11-0328-04	COLOR FILTER		
614	3A		B43-0302-04	KENWOOD BADGE		
-			B46-0092-43	WARRANTY CARD	K	
-			B46-0096-53	WARRANTY CARD	X	
-			B46-0121-33	WARRANTY CARD	P	
-			B46-0197-00	QUESTIONNAIRE CARD	K	
-			B46-0310-03	WARRANTY CARD	TE	4
-			B46-0326-03	WARRANTY CARD	C	
-			B58-0964-13	CAUTION CARD (UL)	K	
-			B58-0965-13	CAUTION CARD (PL)	XT	
-			B58-0966-13	CAUTION CARD (PL)	MCE	
-			B58-0967-03	CAUTION CARD (PL)	P	
-		*	B60-2549-00	INSTRUCTION MANUAL(ENGLISH)	KPMCX	
-		*	B60-2550-00	INSTRUCTION MANUAL(FRENCH)	P	
-		*	B60-2551-00	INSTRUCTION MANUAL(SPANISH)	M	
-		*	B60-2552-00	INSTRUCTION MANUAL(CHINESE)	MC	
-		*	B60-2553-00	INSTRUCTION MANUAL(TAIWAN)	M	
-		*	B60-2554-00	INSTRUCTION MANUAL(ENGLISH)	T	4
-		*	B60-2555-00	INSTRUCTION MANUAL(F/G/D/I/S)	E	4
620	2C	*	D21-1829-13	EXTENSION SHAFT	MCXTE	
△ 625	1A		E03-0115-05	AC PLUG ADAPTER	M	
△ 626	1D		E30-2714-05	AC POWER CORD	X	4
△ 626	1D		E30-2718-05	AC POWER CORD	T	4
△ 626	1D		E30-2826-05	AC POWER CORD	KP	
△ 626	1D		E30-2827-05	AC POWER CORD	ME	
△ 626	1D	*	E30-2833-05	AC POWER CORD	C	
-		*	E29-1617-14	LEAD PLATE	KP	
-		*	G11-2258-04	CUSHION		
-		*	H10-7148-12	POLYSTYRENE FOAMED FIXTURE	KPMCXE	
-		*	H10-7149-12	POLYSTYRENE FOAMED FIXTURE	KPMCXE	
-		*	H10-7150-12	POLYSTYRENE FOAMED FIXTURE	T	
-		*	H10-7151-12	POLYSTYRENE FOAMED FIXTURE	T	
-		*	H11-0070-04	POLYSTYRENE FOAMED BOARD		
-		*	H13-0231-04	CARTON BOARD	X	4
-		*	H25-0232-04	PROTECTION BAG (235X350X0.03)	KPMCXE	
-		*	H25-0391-04	PROTECTION BAG		
-		*	H25-0651-04	PROTECTION BAG	T	
-		*	H50-1796-14	ITEM CARTON CASE	KP	5

L : Scandinavia K : USA P : Canada R : Mexico 2 : KR-A2080 3 : KR-A3080
Y : PX(Far East, Hawaii) T : Europe E : Europe G : Germany 4 : KR-A4080 5 : KR-A5080
Y : AAFES(Europe) X : Australia M : Other Areas C : CHINESE

△ indicates safety critical components.

* New Parts
Parts without **Parts No.** are not supplied.
Les articles non mentionnés dans le **Parts No.** ne sont pas fournis.
Teile ohne **Parts No.** werden nicht geliefert.

②

Ref. No	Add-ress	New Parts	Parts No.	Description	Desti-nation	Re-marks
-		*	H50-1860-14	ITEM CARTON CASE	M	5
-		*	H50-1861-14	ITEM CARTON CASE	C	5
-		*	H50-1862-14	ITEM CARTON CASE	KPXE	4
-		*	H50-1863-14	ITEM CARTON CASE	T	4
-		*	H50-1864-14	ITEM CARTON CASE	M	4
-		*	H50-1865-14	ITEM CARTON CASE	C	4
630	3C,3D		J02-0366-15	FOOT	K	
630	3C,3D		J02-1149-05	FOOT	PMCXTE	
631	3B		J19-2808-05	HOLDER		
632	2C		J19-3731-04	UNIT HOLDER		
△ 633	1D		J42-0083-05	POWER CORD BUSHING		
-			J61-0307-05	WIRE BAND		
637	2B		K27-2185-04	KNOB (BUTTON) POWER	MCXTE	
638	2B		K29-6321-04	KNOB LOUDNESS		
639	3B		K29-6322-04	KNOB		
640	3A	*	K29-6323-12	KNOB		
645	2B	*	L07-2066-05	POWER TRANSFORMER	KP	5
645	2B	*	L07-2067-05	POWER TRANSFORMER	M	5
645	2B	*	L07-2068-05	POWER TRANSFORMER	X	4
645	2B	*	L07-2069-05	POWER TRANSFORMER	KP	4
645	2B	*	L07-2070-05	POWER TRANSFORMER	M	4
645	2B	*	L07-2071-05	POWER TRANSFORMER	TE	4
645	2B	*	L07-2076-05	POWER TRANSFORMER	C	5
645	2B	*	L07-2077-05	POWER TRANSFORMER	C	4
651	1A		T90-0195-05	LOOP ANTENNA		
652	1A		T90-0801-05	LEAD WIRE ANTENNA	KPMCX	
652	1A		T90-0810-05	LEAD WIRE ANTENNA	TE	4
KR-A2080/A3080						
601	1B		A01-3300-11	METALLIC CABINET		
602	1A		A09-0341-08	BATTERY COVER		
604	3B	*	A60-0879-01	PANEL	KPMTE	3
604	3B	*	A60-0880-01	PANEL	KP	
604	3B	*	A60-0881-01	PANEL	M	
604	3B	*	A60-0881-01	PANEL	TE	3
604	3B	*	A60-0883-01	PANEL	E	2
605	1A	*	A70-1057-05	REMOTE CONTROLLER ASSY KPM		
605	1A	*	A70-1058-05	REMOTE CONTROLLER ASSY TE 3		
610	3A		B03-2966-04	DRESSING PLATE		
611	3A		B07-2298-02	ESCUTCHEON		
612	3A		B10-2203-12	FRONT GLASS		
612	3A	*	B10-2213-22	FRONT GLASS	KPM	
612	3A	*	B10-2235-12	FRONT GLASS	E	2
613	3A		B11-0328-04	COLOR FILTER	TE	3
614	2A		B43-0302-04	KENWOOD BADGE		
-			B46-0092-43	WARRANTY CARD	K	
-			B46-0121-33	WARRANTY CARD	P	
-			B46-0197-00	QUESTIONNAIRE CARD	K	
-			B46-0310-03	WARRANTY CARD TE		
-			B58-0964-13	CAUTION CARD (UL)	K	
-			B58-0965-13	CAUTION CARD (PL)	T	
-			B58-0966-13	CAUTION CARD (PL)	ME	
-			B58-0967-03	CAUTION CARD (PL)	P	
-		*	B60-2557-00	INSTRUCTION MANUAL(ENG)	KPM	

L : Scandinavia K : USA P : Canada R : Mexico 2 : KR-A2080 3 : KR-A3080
Y : PX(Far East, Hawaii) T : Europe E : Europe G : Germany 4 : KR-A4080 5 : KR-A5080
Y : AAFES(Europe) X : Australia M : Other Areas C : CHINESE

△ indicates safety critical components.

KR-A2080/A3080/A4080/A5080
PARTS LIST

* New Parts
 Parts without **Parts No.** are not supplied.
 Les articles non mentionnés dans le **Parts No.** ne sont pas fournis.
 Teile ohne **Parts No.** werden nicht geliefert.

3

Ref. No	Address	New Parts	Parts No.	Description	Destination	Remarks
-		*	B60-2558-00	INSTRUCTION MANUAL(ENG)	T	
-		*	B60-2559-00	INSTRUCTION MANUAL(FRE)	P	
-		*	B60-2560-00	INSTRUCTION MANUAL(GER)	E	3
-		*	B60-2561-00	INSTRUCTION MANUAL(F/D/I/S)	E	3
-		*	B60-2562-00	INSTRUCTION MANUAL(SF/CHI)	M	
-		*	B60-2564-00	INSTRUCTION MANUAL(TAIWAN)	M	
-		*	B60-2565-00	INSTRUCTION MANUAL(F/G/D/I)	E	2
620	2C		D21-1829-13	EXTENSION SHAFT	MTE	
Δ 625	1A		E03-0115-05	AC PLUG ADAPTER	M	
Δ 626	1D		E30-2718-05	AC POWER CORD	T	
Δ 626	1D		E30-2826-05	AC POWER CORD	KP	
Δ 626	1D		E30-2827-05	AC POWER CORD	ME	
-			E29-1617-14	LEAD PLATE	KP	
-			G11-2258-04	CUSHION		
-			H10-7148-12	POLYSTYRENE FOAMED FIXTURE	KPME	
-			H10-7149-12	POLYSTYRENE FOAMED FIXTURE	KPME	
-			H10-7150-12	POLYSTYRENE FOAMED FIXTURE	T	
-			H10-7151-12	POLYSTYRENE FOAMED FIXTURE	T	
-			H11-0070-04	POLYSTYRENE FOAMED BOARD		
-			H25-0232-04	PROTECTION BAG (235X350X0.03)	KPME	
-			H25-0391-04	PROTECTION BAG		
-			H25-0651-04	PROTECTION BAG T		
-		*	H50-1866-14	ITEM CARTON CASE	KPE	3
-		*	H50-1867-14	ITEM CARTON CASE	T	
-		*	H50-1868-14	ITEM CARTON CASE	M	
-		*	H50-1869-14	ITEM CARTON CASE	E	2
630	3C,3D		J02-0366-15	FOOT	K	
630	3C,3D		J02-1149-05	FOOT	PMTE	
631	3B		J19-2808-05	HOLDER		
632	2C		J19-3731-04	UNIT HOLDER		
633	1D		J42-0083-05	POWER CORD BUSHING		
-			J61-0307-05	WIRE BAND		
637	2B		K27-2185-04	KNOB (BUTTON) POWER	MTE	
638	2B		K29-6321-04	KNOB		
639	3B		K29-6322-04	KNOB		
640	3A		K29-6323-12	KNOB		
Δ 645	2B	*	L07-2072-05	POWER TRANSFORMER	KP	
Δ 645	2B	*	L07-2073-05	POWER TRANSFORMER	M	
Δ 645	2B	*	L07-2075-05	POWER TRANSFORMER	TE	
651	1A		T90-0195-05	LOOP ANTENNA		
652	1A		T90-0801-05	LEAD WIRE ANTENNA	KPM	
652	1A		T90-0810-05	LEAD WIRE ANTENNA	TE	
POWER SUPPLY UNIT (X00-28 * * - * *)						
C1,2			CE04LW1A470M	ELECTRO 47UF 10WV		
C3			CE04EW1E331M	ELECTRO 330UF 25WV		
C4			CE04LW1V4R7M	ELECTRO 4.7UF 35WV		
C5			CK45FF1H103Z	CERAMIC 0.010UF Z		
Δ C6			C91-1488-05	MF 6800PF 250VAC		
C7			CK45FF1H103Z	CERAMIC 0.010UF Z		
C8,9			CC45FSL1H221J	CERAMIC 220PF J		
C10			CK45FF1H473Z	CERAMIC 0.047UF Z		

L : Scandinavia K : USA P : Canada R : Mexico 2 : KR-A2080 3 : KR-A3080
 Y : PX(Far East, Hawaii) T : Europe E : Europe G : Germany 4 : KR-A4080 5 : KR-A5080
 Y : AAFES(Europe) X : Australia M : Other Areas C : CHINESE

Δ indicates safety critical components.

* New Parts
 Parts without **Parts No.** are not supplied.
 Les articles non mentionnés dans le **Parts No.** ne sont pas fournis.
 Teile ohne **Parts No.** werden nicht geliefert.

4

Ref. No	Address	New Parts	Parts No.	Description	Destination	Remarks
C11			C91-1488-05	MF 6800PF 250VAC		
Δ CN7			E40-4297-05	FLAT CABLE CONNECTOR		
J1	1C		E11-0188-05	MINIATURE PHONE JACK(2P)		
Δ J2	1C		E03-0148-05	AC OUTLET	KP	
Δ J2	1C		E03-0149-05	AC OUTLET	M	
Δ J2	1C		E03-0310-05	AC OUTLET	T	
Δ J2	1C		E03-0325-05	AC OUTLET	X	
J2	1C		E03-0330-05	AC OUTLET	C	
F1			F05-1222-05	FUSE (SEMKO) (250V T1.25A L)	T	3
F1			F05-2525-05	FUSE (SEMKO) (250V T2.5AL)	C	5
F1			F05-4028-05	FUSE (UL) (125V 4A)	KP	3
F1			F05-6029-05	FUSE (UL) (125V 6A)	KP	4
F1			F05-6029-05	FUSE (UL) (125V 6A)	KP	5
F1			F06-2021-05	FUSE (SEMKO) (250V T2AL)	CXT	4
F1,2			F05-1222-05	FUSE (SEMKO) (250V T1.25A L)	M	3
F1,2			F05-2525-05	FUSE (SEMKO) (250V T2.5AL)	M	5
F1,2			F06-2021-05	FUSE (SEMKO) (250V T2AL)	M	4
F3			F05-2525-05	FUSE (SEMKO) (250V T2.5AL)	T	3
F3			F05-2525-05	FUSE (SEMKO) (250V T2.5AL)	T	4
CN1-4			J13-0075-05	FUSE CLIP	M	
CN1,2			J13-0075-05	FUSE CLIP	KPCXT	
CN5,6			J13-0075-05	FUSE CLIP	T	
Δ T1		*	L07-2127-05	POWER TRANSFORMER	KP	
Δ T1		*	L07-2128-05	POWER TRANSFORMER	MC	
Δ T1		*	L07-2129-05	POWER TRANSFORMER	XT	
Δ R5			R92-1769-05	CARBON 3.3M J 1/2W	KP	
Δ K1			S76-0044-05	MAGNETIC RELAY		
S1			S68-0056-05	PUSH SWITCH	MCXT	
S2			S31-3010-05	SLIDE SWITCH	M	
D1			HZS6.2N(B2)	ZENER DIODE		
D1			RD6.2ES(B2)	ZENER DIODE		
D2-5			S5688B	DIODE		
D2-5			1SR139-100	DIODE		
D6-10			HSS104A	DIODE		
D6-10			1SS131	DIODE		
Q1			2SC3940A(R,S)	TRANSISTOR		
Q1			2SD863(E,F)	TRANSISTOR		
Q2			2SC1740S(Q,R)	TRANSISTOR		
Q2			2SC2785(F,E)	TRANSISTOR		
C1,2			CE04LW1A470M	ELECTRO 47UF 10WV		
C3			CE04EW1E331M	ELECTRO 330UF 25WV		
C4			CE04LW1V4R7M	ELECTRO 4.7UF 35WV		
C5			CK45FF1H103Z	CERAMIC 0.010UF Z		
Δ C6			C91-1488-05	MF 6800PF 250VAC		
C7			CK45FF1H103Z	CERAMIC 0.010UF Z		
C8,9			CC45FSL1H221J	CERAMIC 220PF J		
C10			CK45FF1H473Z	CERAMIC 0.047UF Z		
Δ C11			C91-1488-05	MF 6800PF 250VAC		
CN7			E40-4297-05	FLAT CABLE CONNECTOR		
J1			E11-0188-05	MINIATURE PHONE JACK(2P)		

L : Scandinavia K : USA P : Canada R : Mexico 2 : KR-A2080 3 : KR-A3080
 Y : PX(Far East, Hawaii) T : Europe E : Europe G : Germany 4 : KR-A4080 5 : KR-A5080
 Y : AAFES(Europe) X : Australia M : Other Areas C : CHINESE

Δ indicates safety critical components.

KR-A2080/A3080/A4080/A5080
PARTS LIST

* New Parts

Parts without **Parts No.** are not supplied.
Les articles non mentionnés dans le **Parts No.** ne sont pas fournis.
Teile ohne **Parts No.** werden nicht geliefert.

5

Ref. No	Add-ress	New Parts	Parts No.	Description	Desti-nation	Re-marks
Δ J2			E03-0149-05	AC OUTLET		
F1			F05-1222-05	FUSE (SEMKO) (250V T1.25A L)		2
F1			F05-1222-05	FUSE (SEMKO) (250V T1.25A L)		3
F1			F06-2021-05	FUSE (SEMKO) (250V T2AL)		4
F3			F05-2525-05	FUSE (SEMKO) (250V T2.5AL)		4
F3			F05-2525-05	FUSE (SEMKO) (250V T2.5AL)		2
F3			F05-2525-05	FUSE (SEMKO) (250V T2.5AL)		3
CN1,2			J13-0075-05	FUSE CLIP		
CN5,6			J13-0075-05	FUSE CLIP		
Δ K1			S76-0044-05	MAGNETIC RELAY		
Δ S1	*		S68-0056-05	PUSH SWITCH		
D1			HZS6.2N(B2)	ZENER DIODE		
D1			RD6.2ES(B2)	ZENER DIODE		
D2-5			S5688B	DIODE		
D2-5			1SR139-100	DIODE		
D6-10			HSS104A	DIODE		
D6-10			1SS131	DIODE		
Q1			2SC3940A(R,S)	TRANSISTOR		
Q1			2SD863(E,F)	TRANSISTOR		
Q2			2SC1740S(Q,R)	TRANSISTOR		
Q2			2SC2785(F,E)	TRANSISTOR		
TUNER UNIT (X05-459 * - * *)						
C1,2			CK73FB1H103K	CHIP C 0.010UF K		
C3			CE04LW1A101M	ELECTRO 100UF 10WV		
C4			CK73FB1H223K	CHIP C 0.022UF K		
C5			CE04LW1H010M	ELECTRO 1.0UF 50WV		
C6			CK73FB1H103K	CHIP C 0.010UF K		
C7			CK73FF1C105Z	CHIP C 1.0UF Z		
C8			CC73FCH1H220J	CHIP C 22PF J		
C9,10			CK73FB1H123K	CHIP C 0.012UF K	MCXTE	
C9,10			CK73FB1H183K	CHIP C 0.018UF K	KP	
C11			CE04LW1HR22M	ELECTRO 0.22UF 50WV		
C12			CK73FB1H473K	CHIP C 0.047UF K		
C13			CE04LW1C100M	ELECTRO 10UF 16WV		
C14			CE04LW1H010M	ELECTRO 1.0UF 50WV		
C15			CC73FSL1H121J	CHIP C 120PF J	KPMCX	
C15			CC73FSL1H681J	CHIP C 680PF J	TE	
C16			CC73FSL1H101J	CHIP C 100PF J		
C17			CK73FB1H152K	CHIP C 1500PF K		
C20			CK73FB1H682K	CHIP C 6800PF K		
C21			CE04LW1C100M	ELECTRO 10UF 16WV		
C22			CK73FB1H223K	CHIP C 0.022UF K		
C23			CE04LW1H2R2M	ELECTRO 2.2UF 50WV		
C24			CE04LW1A101M	ELECTRO 100UF 10WV		
C25			CK73FB1H223K	CHIP C 0.022UF K		
C26			CK73FB1H103K	CHIP C 0.010UF K		
C30			CC73FSL1H150J	CHIP C 15PF J		
C31			CK73FB1H473K	CHIP C 0.047UF K		
C32			CC73FCH1H060D	CHIP C 6.0PF D	TE	
C33			CC73FCH1H220J	CHIP C 22PF J	TE	
C34			CC73FCH1H220J	CHIP C 22PF J	TE	
C40			CK73FB1H103K	CHIP C 0.010UF K		

L : Scandinavia K : USA P : Canada R : Mexico 2 : KR-A2080 3 : KR-A3080
Y : PX(Far East, Hawaii) T : Europe E : Europe G : Germany 4 : KR-A4080 5 : KR-A5080
Y : AAFES(Europe) X : Australia M : Other Areas C : CHINESE

Δ indicates safety critical components.

* New Parts

Parts without **Parts No.** are not supplied.
Les articles non mentionnés dans le **Parts No.** ne sont pas fournis.
Teile ohne **Parts No.** werden nicht geliefert.

6

Ref. No	Add-ress	New Parts	Parts No.	Description	Desti-nation	Re-marks
C41			CE04LW1C470M	ELECTRO 47UF 16WV		
C42			CQ93FMG1H223J	MYLAR 0.022UF J		
C43			CE04HW1H2R2M	NP-ELEC 2.2UF 50WV		
C44			CE04LW1C470M	ELECTRO 47UF 16WV		
C45-47			CK73FB1H102K	CHIP C 1000PF K		
C48			CC73FCH1H270J	CHIP C 27PF J		
C49			CC73FCH1H220J	CHIP C 22PF J		
C52			CC73FSL1H471J	CHIP C 470PF J		
C53			CE04LW1C470M	ELECTRO 47UF 16WV		
C54			CE04LW1H010M	ELECTRO 1.0UF 50WV		
C60,61			CK73FB1H682K	CHIP C 6800PF K	MC	
C62,63			CE04LW1H010M	ELECTRO 1.0UF 50WV		
C64,65			CK73FB1H562K	CHIP C 5600PF K	TE	
C66,67			CE04LW1H010M	ELECTRO 1.0UF 50WV	KPMCX	
C66,67			CE04LW1H100M	ELECTRO 10UF 50WV	TE	
C69,70			CK73FB1H103K	CHIP C 0.010UF K	TE	
C100			CC73FCH1H330J	CHIP C 33PF J	TE	3
C100			CC73FCH1H330J	CHIP C 33PF J	TE	4
C101-104			CK73FB1H102K	CHIP C 1000PF K	TE	3
C101-104			CK73FB1H102K	CHIP C 1000PF K	TE	4
C105			CE04LW1H0R1M	ELECTRO 0.1UF 50WV	TE	3
C105			CE04LW1H0R1M	ELECTRO 0.1UF 50WV	TE	4
CN1		*	E40-9905-05	SOCKET FOR PIN ASSY	KPMCX	
CN1		*	E40-9905-05	SOCKET FOR PIN ASSY	E	2
CN1		*	E40-9907-05	SOCKET FOR PIN ASSY	TE	
CN2			E40-4871-05	PIN ASSY		
J1	2D		E70-0051-05	LOCK TERMINAL BOARD	KPMCX	
J1	2D		E70-0052-05	LOCK TERMINAL BOARD	TE	
J2			F10-1004-04	SHIELDING PLATE	KPMCX	
J2			F10-1005-04	SHIELDING PLATE	TE	
CF1,2			L72-0531-05	CERAMIC FILTER	KPMCX	
CF1,2			L72-0536-05	CERAMIC FILTER	TE	
L1			L40-1091-17	SMALL FIXED INDUCTOR(1UH)		
L2			L40-1001-17	SMALL FIXED INDUCTOR(10UH,K)	TE	
L3			L30-0467-05	AM IFT		
L4			L79-1227-05	LC FILTER	TE	
L5			L30-0921-05	FM IFT		
L6			L40-1091-17	SMALL FIXED INDUCTOR(1UH)		
L7			L39-1328-05	COMBINATION COIL		
L8,9			L79-1219-05	LC FILTER	TE	
L10			L40-1011-17	SMALL FIXED INDUCTOR(100UH,K)		
X1			L77-2148-05	CRYSTAL RESONATOR(7.2MHZ)		
R2			RK73FB2A681J	CHIP R 680 J 1/10W		
R3			RK73FB2A331J	CHIP R 330 J 1/10W		
R4			RK73FB2A100J	CHIP R 10 J 1/10W		
R5			RK73FB2A331J	CHIP R 330 J 1/10W		
R6			RK73FB2A332J	CHIP R 3.3K J 1/10W		
R7			RK73FB2A101J	CHIP R 100 J 1/10W		
R8			RK73FB2A331J	CHIP R 330 J 1/10W		
R10			RD14NB2E121J	RD 120 J 1/4W		
R11			RK73FB2A103J	CHIP R 10K J 1/10W	KPMCX	
R11			RK73FB2A133J	CHIP R 13K J 1/10W	TE	

L : Scandinavia K : USA P : Canada R : Mexico 2 : KR-A2080 3 : KR-A3080
Y : PX(Far East, Hawaii) T : Europe E : Europe G : Germany 4 : KR-A4080 5 : KR-A5080
Y : AAFES(Europe) X : Australia M : Other Areas C : CHINESE

Δ indicates safety critical components.

PARTS LIST

KR-A2080/A3080/A4080/A5080

* New Parts
 Parts without **Parts No.** are not supplied.
 Les articles non mentionnes dans le **Parts No.** ne sont pas fournis.
 Teile ohne **Parts No.** werden nicht geliefert.

7

Ref. No	Add-ress	New Parts	Parts No.	Description	Desti-nation	Re-marks
R12			RK73FB2A392J	CHIP R 3.9K	J 1/10W	
R13			RK73FB2A332J	CHIP R 3.3K	J 1/10W	
R14			RK73FB2A473J	CHIP R 47K	J 1/10W	
R15			RK73EB2B473J	CHIP R 47K	J 1/8W	
R18			RK73EB2B562J	CHIP R 5.6K	J 1/8W	
R19			RK73FB2A133J	CHIP R 13K	J 1/10W	KPMCX
R19			RK73FB2A622J	CHIP R 6.2K	J 1/10W	TE
R20			RK73FB2A332J	CHIP R 3.3K	J 1/10W	TE
R21			RK73FB2A222J	CHIP R 2.2K	J 1/10W	TE
R23			RK73FB2A123J	CHIP R 12K	J 1/10W	KPMC
R23			RK73FB2A223J	CHIP R 22K	J 1/10W	XTE
R30			RK73FB2A104J	CHIP R 100K	J 1/10W	
R40			RD14NB2E561J	RD 560	J 1/4W	
R41			RK73FB2A102J	CHIP R 1.0K	J 1/10W	
R43			RK73FB2A562J	CHIP R 5.6K	J 1/10W	
R44			RK73FB2A222J	CHIP R 2.2K	J 1/10W	
R45			RK73FB2A102J	CHIP R 1.0K	J 1/10W	
R46			RK73FB2A103J	CHIP R 10K	J 1/10W	
R47-51			RK73FB2A102J	CHIP R 1.0K	J 1/10W	
R52			RK73FB2A123J	CHIP R 12K	J 1/10W	
R53			RK73FB2A122J	CHIP R 1.2K	J 1/10W	
R56			RD14NB2E820J	RD 82	J 1/4W	
R57			RD14NB2E221J	RD 220	J 1/4W	
R58			RK73EB2B103J	CHIP R 10K	J 1/8W	
R60,61			RK73FB2A561J	CHIP R 560	J 1/10W	MC
R62,63			RK73EB2B473J	CHIP R 47K	J 1/8W	MC
R64,65			RK73FB2A122J	CHIP R 1.2K	J 1/10W	TE
R66,67			RK73FB2A473J	CHIP R 47K	J 1/10W	
R68,69			RK73FB2A562J	CHIP R 5.6K	J 1/10W	KPMCX
R68,69			RK73FB2A682J	CHIP R 6.8K	J 1/10W	TE
R70,71			RK73FB2A103J	CHIP R 10K	J 1/10W	
R72,73			RK73FB2A332J	CHIP R 3.3K	J 1/10W	KPMCX
R74-76			RK73FB2A472J	CHIP R 4.7K	J 1/10W	TE
R74,75			RK73FB2A393J	CHIP R 39K	J 1/10W	KPMCX
R76			RK73FB2A472J	CHIP R 4.7K	J 1/10W	KPMCX
R77			RK73FB2A473J	CHIP R 47K	J 1/10W	
R78,79			RK73FB2A561J	CHIP R 560	J 1/10W	
R99			RK73FB2A473J	CHIP R 47K	J 1/10W	TE
R100			RK73FB2A122J	CHIP R 1.2K	J 1/10W	TE
R100			RK73FB2A122J	CHIP R 1.2K	J 1/10W	TE
R101			RK73FB2A750J	CHIP R 75	J 1/10W	TE
R101			RK73FB2A750J	CHIP R 75	J 1/10W	TE
R102			RK73FB2A681J	CHIP R 680	J 1/10W	TE
R102			RK73FB2A681J	CHIP R 680	J 1/10W	TE
R103			RK73FB2A621J	CHIP R 620	J 1/10W	TE
R103			RK73FB2A621J	CHIP R 620	J 1/10W	TE
R104			RK73FB2A104J	CHIP R 100K	J 1/10W	TE
R104			RK73FB2A104J	CHIP R 100K	J 1/10W	TE
R105			RK73FB2A471J	CHIP R 470	J 1/10W	TE
R105			RK73FB2A471J	CHIP R 470	J 1/10W	TE
R106			RK73FB2A181J	CHIP R 180	J 1/10W	TE
R106			RK73FB2A181J	CHIP R 180	J 1/10W	TE
R107			RK73FB2A104J	CHIP R 100K	J 1/10W	TE
R107			RK73FB2A104J	CHIP R 100K	J 1/10W	TE
R108			RK73FB2A103J	CHIP R 10K	J 1/10W	TE

L : Scandinavia K : USA P : Canada R : Mexico 2 : KR-A2080 3 : KR-A3080
 Y : PXI(Far East, Hawaii) T : Europe E : Germany G : Germany 4 : KR-A4080 5 : KR-A5080
 Y : AAFES(Europe) X : Australia M : Other Areas C : CHINESE

△ indicates safety critical components.

* New Parts
 Parts without **Parts No.** are not supplied.
 Les articles non mentionnes dans le **Parts No.** ne sont pas fournis.
 Teile ohne **Parts No.** werden nicht geliefert.

8

Ref. No	Add-ress	New Parts	Parts No.	Description	Desti-nation	Re-marks
R108			RK73FB2A103J	CHIP R 10K	J 1/10W	TE
R109,110			RK73FB2A223J	CHIP R 22K	J 1/10W	TE
R109,110			RK73FB2A223J	CHIP R 22K	J 1/10W	TE
R111			RK73FB2A104J	CHIP R 100K	J 1/10W	TE
R112			RK73FB2A473J	CHIP R 47K	J 1/10W	TE
R112			RK73FB2A683J	CHIP R 68K	J 1/10W	TE
R113			RK73FB2A683J	CHIP R 68K	J 1/10W	TE
R115			RK73FB2A102J	CHIP R 1.0K	J 1/10W	TE
R115			RK73FB2A102J	CHIP R 1.0K	J 1/10W	TE
R116			RK73FB2A104J	CHIP R 100K	J 1/10W	TE
R116			RK73FB2A104J	CHIP R 100K	J 1/10W	TE
W100-104			R92-0670-05	CHIP R 0 OHM		TE
W100-104			R92-0670-05	CHIP R 0 OHM		TE
W102,103			R92-0670-05	CHIP R 0 OHM		KPMCX
W105-115			R92-0670-05	CHIP R 0 OHM		KPX
W105-117			R92-0670-05	CHIP R 0 OHM		MC
W106-115			R92-0670-05	CHIP R 0 OHM		TE
W117			R92-0670-05	CHIP R 0 OHM		KPXTE
W120,121			R92-0670-05	CHIP R 0 OHM		KPMCX
W123-126			R92-0670-05	CHIP R 0 OHM		TE
W123,124			R92-0670-05	CHIP R 0 OHM		KPMCX
W200			R92-0679-05	CHIP R 0 OHM		TE
W202			R92-0679-05	CHIP R 0 OHM		TE
W204			R92-0679-05	CHIP R 0 OHM		TE
S1	1D		S62-0034-05	SLIDE SWITCH		MC
D1,2			HSS104	DIODE		
D1,2			1SS133	DIODE		
D3			HZS6.8N(B2)	ZENER DIODE		
D3			RD6.8ES(B2)	ZENER DIODE		
D6			MA111	DIODE		
D7			HZS5.1N(B2)	ZENER DIODE		
D7			RD5.1ES(B2)	ZENER DIODE		
D100			1SS268	DIODE		TE
D100			1SS268	DIODE		TE
D101,102			MA111	DIODE		TE
D101,102			MA111	DIODE		TE
IC1			BA1450S	ANALOGUE IC		
IC2			LC72131	MOS-IC		
IC3			NJM4565M	IC(OP AMP X2)		
IC100			M5223FP	IC(OP AMP X4)		TE
IC100			M5223FP	IC(OP AMP X4)		TE
Q1			2SC2714(R,O)	TRANSISTOR		
Q2			2SC4116(Y,GR)	TRANSISTOR		TE
Q2			2SC4116(Y,GR)	TRANSISTOR		TE
Q2			2SC4116(Y,GR)	TRANSISTOR		TE
Q2			2SC4177(L5,L6)	TRANSISTOR		TE
Q2			2SC4177(L5,L6)	TRANSISTOR		TE
Q2			2SC4177(L5,L6)	TRANSISTOR		TE
Q3			2SC4116(Y,GR)	TRANSISTOR		TE
Q3			2SC4177(L5,L6)	TRANSISTOR		TE
Q4			2SA1586(Y,GR)	TRANSISTOR		
Q4			2SA1611(M5,M6)	TRANSISTOR		
Q6,7			2SC4116(Y,GR)	TRANSISTOR		MC

L : Scandinavia K : USA P : Canada R : Mexico 2 : KR-A2080 3 : KR-A3080
 Y : PXI(Far East, Hawaii) T : Europe E : Europe G : Germany 4 : KR-A4080 5 : KR-A5080
 Y : AAFES(Europe) X : Australia M : Other Areas C : CHINESE

△ indicates safety critical components.

KR-A2080/A3080/A4080/A5080

PARTS LIST

* New Parts

Parts without **Parts No.** are not supplied.

Les articles non mentionnés dans le **Parts No.** ne sont pas fournis.

Teile ohne **Parts No.** werden nicht geliefert.

9

Ref. No	Add-ress	New Parts	Parts No.	Description	Desti-nation	Re-marks
Q6,7			2SC4177(L5,L6)	TRANSISTOR	MC	
Q8,9			2SD1757K	TRANSISTOR		
Q100			2SC4116(Y,GR)	TRANSISTOR	TE	3
Q100			2SC4116(Y,GR)	TRANSISTOR	TE	4
Q100			2SC4177(L5,L6)	TRANSISTOR	TE	3
Q100			2SC4177(L5,L6)	TRANSISTOR	TE	4
Q101			2SA1586(Y,GR)	TRANSISTOR	TE	3
Q101			2SA1586(Y,GR)	TRANSISTOR	TE	4
Q101			2SA1611(M5,M6)	TRANSISTOR	TE	3
Q101			2SA1611(M5,M6)	TRANSISTOR	TE	4
A1			W02-2539-05	FM FRONT-END ASSY	KPMCX	
A1		*	W02-2540-15	FM FRONT-END ASSY	TE	
AUDIO UNIT (X09-442 * - * *)						
D411			B30-1291-05	LED		
C1,2			CC73FSL1H390J	CHIP C	TE	
C3,4			CE04KW1C100M	ELECTRO		
C5,6			CC73FSL1H471J	CHIP C	TE	
C7,8			C90-3618-05	ELECTRO		
C9,10			CC73FSL1H221J	CHIP C		
C11,12			CK73FB1H123K	CHIP C		
C13,14			CK73FB1H332K	CHIP C		
C15,16			C90-3617-05	ELECTRO		
C17,18			CK73FB1H103K	CHIP C		
C19-26			CC73FSL1H221J	CHIP C	TE	
C27,28			CC73FSL1H471J	CHIP C	TE	4
C29-32			CC73FSL1H221J	CHIP C	TE	
C33,34			CK73FB1H103K	CHIP C		
C35,36			CK73FB1H103K	CHIP C		
C35,36			CK73FB1H103K	CHIP C		
C37,38			CE04KW1A470M	ELECTRO		
C39,40			C90-3617-05	ELECTRO		
C41,42			CC73FSL1H221J	CHIP C		
C43,44			C90-3617-05	ELECTRO		
C45-50			CK73FB1H103K	CHIP C		
C45-50			CK73FB1H103K	CHIP C		
C45,46			CK73FB1H103K	CHIP C		
C45,46			CK73FB1H103K	CHIP C		
C49,50			CK73FB1H103K	CHIP C		
C49,50			CK73FB1H103K	CHIP C		
C51,52			CK73FB1H103K	CHIP C		
C51,52			CK73FB1H103K	CHIP C		
C53,54			CE04KW1H0R1M	ELECTRO		
C53,54			CE04KW1H0R1M	ELECTRO		
C55,56			C90-3619-05	ELECTRO		
C55,56			C90-3619-05	ELECTRO		
C57			CK73FB1H472K	CHIP C		
C57			CK73FB1H472K	CHIP C		
C58			C90-3615-05	ELECTRO		
C58			C90-3615-05	ELECTRO		
C59,60			CE04KW1C100M	ELECTRO		
C59,60			CE04KW1C100M	ELECTRO		
C61,62			CE04KW1H2R2M	ELECTRO		
C63,64			CK73FF1E104Z	CHIP C		
C65,66			CK73FB1H272K	CHIP C		

L : Scandinavia K : USA P : Canada R : Mexico 2 : KR-A2080 3 : KR-A3080
 Y : PX(Far East, Hawaii) T : Europe E : Europe G : Germany 4 : KR-A4080 5 : KR-A5080
 V : AAFES(Europe) X : Australia M : Other Areas C : CHINESE

△ indicates safety critical components.

* New Parts

Parts without **Parts No.** are not supplied.

Les articles non mentionnés dans le **Parts No.** ne sont pas fournis.

Teile ohne **Parts No.** werden nicht geliefert.

10

Ref. No	Add-ress	New Parts	Parts No.	Description	Desti-nation	Re-marks
C67-70			CK73FF1E104Z	CHIP C		
C71-74			CE04KW1H010M	ELECTRO		
C75,76			CC73FSL1H101J	CHIP C		
C77			CE04KW1C470M	ELECTRO		
C78,79			CE04KW1C220M	ELECTRO		
C81			CE04KW1C470M	ELECTRO		
C82			CE04KW1C220M	ELECTRO		
C83,84			CK73FB1H102K	CHIP C		
C83,84			CK73FB1H102K	CHIP C		
C83,84			CK73FB1H182K	CHIP C		
C83,84			CK73FB1H182K	CHIP C		
C83,84			CK73FB1H182K	CHIP C		
C85,86			CE04KW1HR33M	ELECTRO		
C87			CE04KW1C220M	ELECTRO		
C131,132			CE04KW1H3R3M	ELECTRO		
C133,134			CC45FSL1H221J	CERAMIC		
C137,138			CE04KW1A221M	ELECTRO		
C139,140			CC45FSL1H101J	CERAMIC		
C141,142			CC45FSL1H101J	CERAMIC		
C141,142			CC45FSL1H101J	CERAMIC		
C141,142			CC45FSL1H820J	CERAMIC		
C141,142			CK45FB1H471K	CERAMIC		
C143,144			CE04KW2A010M	ELECTRO		
C145,146			CC45FSL1H050C	CERAMIC		
C147,148			CC45FSL2H330J	CERAMIC		
C149,150			CK45FF1H103Z	CERAMIC		
C151-154			CF92FV1H224J	MF-C		
C151,152			CF92FV1H104J	MF-C		
C155-158			CF92FV1H822J	MF-C		
C155-158			CF92FV1H822J	MF-C		
C155-158			CQ93FMG1H102J	MYLAR		
C155-158			CQ93FMG1H223J	MYLAR		
C161,162			CK45FF1H103Z	CERAMIC		
C163			CE04KW0J221M	ELECTRO		
C164			CE04KW1V4R7M	ELECTRO		
C165			CE04KW2A100M	ELECTRO		
C166			CE04KW2AR47M	ELECTRO		
C166			CE04KW2A100M	ELECTRO		
C166			CE04KW2A100M	ELECTRO		
C166			CE04KW2A100M	ELECTRO		
C171-173			CK73FB1H103K	CHIP C		
C174			CK45FF1H103Z	CERAMIC		
C175,176			CC45FSL1H101J	CERAMIC		
C177-180			CC73FSL1H101J	CHIP C		
C189,190			CK73FB1H103K	CHIP C		
C189,190			CK73FB1H103K	CHIP C		
C191			CK73FB1H223K	CHIP C		
C192			CK45FF1H223Z	CERAMIC		
C193			CK73FB1H103K	CHIP C		
C201,202			CK45FF1H103Z	CERAMIC		
C203,204			C91-1480-05	MP		
C205			CK45FF1H103Z	CERAMIC		
C206,207			C90-3536-05	ELECTRO		
C206,207			C90-3604-05	ELECTRO		
C206,207			C90-3605-05	ELECTRO		
C206,207			C90-3605-05	ELECTRO		

L : Scandinavia K : USA P : Canada R : Mexico 2 : KR-A2080 3 : KR-A3080
 Y : PX(Far East, Hawaii) T : Europe E : Europe G : Germany 4 : KR-A4080 5 : KR-A5080
 V : AAFES(Europe) X : Australia M : Other Areas C : CHINESE

△ indicates safety critical components.

PARTS LIST

KR-A2080/A3080/A4080/A5080

* New Parts
 Parts without **Parts No.** are not supplied.
 Les articles non mentionnés dans le **Parts No.** ne sont pas fournis.
 Teile ohne **Parts No.** werden nicht geliefert.

11

Ref. No	Add-ress	New Parts	Parts No.	Description	Desti-nation	Re-marks
C206,207			C90-3612-05	ELECTRO 5600UF 56WV	TE	4
C208			CK45FF1H103Z	CERAMIC 0.010UF Z		
C209			CE04KW1E102M	ELECTRO 1000UF 25WV		
C210			CE04KW1C470M	ELECTRO 47UF 16WV		
C211			CK73FB1H102K	CHIP C 1000PF K		
C212,213			CE04KW1C470M	ELECTRO 47UF 16WV		
C214			CE04KW1J221M	ELECTRO 220UF 63WV	KPMCX	4
C214			CE04KW1J221M	ELECTRO 220UF 63WV	KPMCX	3
C214			CE04KW2A470M	ELECTRO 47UF 100WV	KPMC	5
C216			CK73FB1H102K	CHIP C 1000PF K		
C217			CE04KW1C470M	ELECTRO 47UF 16WV		
C218			CE04KW1V100M	ELECTRO 10UF 35WV		
C219			CF92FV1H104J	MF-C 0.10UF J	E	2
C220			CE04KW1C470M	ELECTRO 47UF 16WV	E	2
C221			CE04KW1V100M	ELECTRO 10UF 35WV	E	2
C222			CE04KW1E470M	ELECTRO 47UF 25WV	KPMCX	
C223			CK45FB1H102K	CERAMIC 1000PF K	KPMCX	
C224			CF92FV1H104J	MF-C 0.10UF J	E	2
C225			CK73FB1H223K	CHIP C 0.022UF K	KPMCX	
C301			CE04KW1H2R2M	ELECTRO 2.2UF 50WV	TE	3
C301			CE04KW1H2R2M	ELECTRO 2.2UF 50WV	TE	4
C302			CC73FSL1H331J	CHIP C 330PF J	TE	3
C302			CC73FSL1H331J	CHIP C 330PF J	TE	4
C303			CK73FB1H561K	CHIP C 560PF K	TE	3
C303			CK73FB1H561K	CHIP C 560PF K	TE	4
C304			CK73FB1H103K	CHIP C 0.010UF K	TE	3
C304			CK73FB1H103K	CHIP C 0.010UF K	TE	4
C305			CE04KW1C100M	ELECTRO 10UF 16WV	TE	3
C305			CE04KW1C100M	ELECTRO 10UF 16WV	TE	4
C306			CC73FCH1H470J	CHIP C 47PF J	TE	3
C306			CC73FCH1H470J	CHIP C 47PF J	TE	4
C307			CC73FCH1H220J	CHIP C 22PF J	TE	3
C307			CC73FCH1H220J	CHIP C 22PF J	TE	4
C307			CC73FCH1H220J	CHIP C 22PF J	TE	4
C308			CK73FB1H103K	CHIP C 0.010UF K	TE	3
C308			CK73FB1H103K	CHIP C 0.010UF K	TE	4
C309			CE04KW1C100M	ELECTRO 10UF 16WV	TE	3
C309			CE04KW1C100M	ELECTRO 10UF 16WV	TE	4
C312			CK73FB1H102K	CHIP C 1000PF K	TE	3
C312			CK73FB1H102K	CHIP C 1000PF K	TE	4
C401			CK73FB1H103K	CHIP C 0.010UF K	TE	4
C402,403			C90-3253-05	ELECTRO 1.0UF 50WV		
C404			C90-1827-05	ELECTRO 0.047F 5.5WV		
C405-406			CK73FB1H103K	CHIP C 0.010UF K		
C407			CK73FB1H103K	CHIP C 0.010UF K		
C407			CK73FB1H103K	CHIP C 0.010UF K		
C407			CK73FB1H103K	CHIP C 0.010UF K		
C408,409			C90-3222-05	ELECTRO 100UF 10WV		
C410			CK73FB1H223K	CHIP C 0.022UF K		
C411,412			C90-3242-05	ELECTRO 4.7UF 35WV		
C413			C90-3260-05	ELECTRO 33UF 50WV		
C414-417			CK73FB1H102K	CHIP C 1000PF K		
CN1		*	E40-9887-05	PIN ASSY	KPMCX	3
CN1		*	E40-9887-05	PIN ASSY	KPMCX	4
CN1		*	E40-9887-05	PIN ASSY	KPMCX	5

L : Scandinavia K : USA P : Canada R : Mexico 2 : KR-A2080 3 : KR-A3080
 Y : PX(Far East, Hawaii) T : Europe E : Europe G : Germany 4 : KR-A4080 5 : KR-A5080
 Y : AAFES(Europe) X : Australia M : Other Areas C : CHINESE

△ indicates safety critical components.

* New Parts
 Parts without **Parts No.** are not supplied.
 Les articles non mentionnés dans le **Parts No.** ne sont pas fournis.
 Teile ohne **Parts No.** werden nicht geliefert.

12

Ref. No	Add-ress	New Parts	Parts No.	Description	Desti-nation	Re-marks
CN1		*	E40-9887-05	PIN ASSY	E	2
CN1		*	E40-9889-05	PIN ASSY	TE	3
CN1		*	E40-9889-05	PIN ASSY	TE	4
J1	1D		E63-0173-05	PHONO JACK		
J2	1D		E63-0172-05	PHONO JACK		
J3	1D		E63-0173-05	PHONO JACK		4
J3	1D		E63-0173-05	PHONO JACK		5
J4	1D		E70-0068-05	LOCK TERMINAL BOARD		
J5	2B		E11-0295-05	PHONE JACK (3P)		
-	-		F20-1322-15	INSULATING BOARD	KPMC	5
-	-		F20-1322-15	INSULATING BOARD	TE	4
-	-		F20-1405-15	INSULATING SHEET	MCX	4
△ F4			F05-8013-05	FUSE (SEMKO) (250V T800MAL)	MCXTE	
△ F4			F06-1222-05	FUSE (UL) (250V 1.25A)	KP	
△ F5,6			F05-6321-05	FUSE (SEMKO) (250V T6.3AL)	MCX	
-		*	J19-5644-03	HOLDER		
CN2,3			J13-0075-05	FUSE CLIP		
CN4-7			J13-0075-05	FUSE CLIP	MCX	
J6			J11-0809-05	WIRE CLAMPER	MCXTE	
J8			J11-0809-05	WIRE CLAMPER		
L1,2			L39-0085-05	PHASE COMPENSATION COIL	TE	
L301,302			L40-1001-17	SMALL FIXED INDUCTOR(10UH,K)	TE	3
L301,302			L40-1001-17	SMALL FIXED INDUCTOR(10UH,K)	TE	4
X301			L77-2002-05	CRYSTAL RESONATOR(4.332MHZ)	TE	3
X301			L77-2002-05	CRYSTAL RESONATOR(4.332MHZ)	TE	4
X302			L78-0244-05	RESONATOR (4.000M)	TE	3
X302			L78-0244-05	RESONATOR (4.000M)	TE	4
X401			L78-0267-05	RESONATOR (4.194MHZ)		
CP401			R90-0500-05	MULTI-COMP 100KX6 J 1/4W		
R1,2			RK73FB2A102J	CHIP R 1.0K J 1/10W		
R3,4			RK73FB2A473J	CHIP R 47K J 1/10W		
R5,6			RK73FB2A101J	CHIP R 100 J 1/10W		
R7,8			RK73FB2A361J	CHIP R 360 J 1/10W		
R9,10			RK73FB2A274J	CHIP R 270K J 1/10W		
R11,12			RK73FB2A223J	CHIP R 22K J 1/10W		
R13,14			RK73FB2A473J	CHIP R 47K J 1/10W		
R19,20			RK73FB2A101J	CHIP R 100 J 1/10W		
R21,22			RK73FB2A104J	CHIP R 100K J 1/10W		
R23,24			RK73FB2A101J	CHIP R 100 J 1/10W		
R25,26			RK73FB2A104J	CHIP R 100K J 1/10W		
R27,28			RK73FB2A101J	CHIP R 100 J 1/10W		
R29,30			RK73FB2A104J	CHIP R 100K J 1/10W		
R31,32			RK73FB2A101J	CHIP R 100 J 1/10W		
R33,34			RK73FB2A104J	CHIP R 100K J 1/10W		
R35,36			RK73FB2A101J	CHIP R 100 J 1/10W		
R35,36			RK73FB2A101J	CHIP R 100 J 1/10W		
R37,38			RK73FB2A104J	CHIP R 100K J 1/10W		
R37,38			RK73FB2A104J	CHIP R 100K J 1/10W		
R39,40			RK73FB2A102J	CHIP R 1.0K J 1/10W		4
R39,40			RK73FB2A102J	CHIP R 1.0K J 1/10W		5
R41,42			RK73FB2A104J	CHIP R 100K J 1/10W		4
R41,42			RK73FB2A104J	CHIP R 100K J 1/10W		5
R43,44			RK73FB2A101J	CHIP R 100 J 1/10W		4

L : Scandinavia K : USA P : Canada R : Mexico 2 : KR-A2080 3 : KR-A3080
 Y : PX(Far East, Hawaii) T : Europe E : Europe G : Germany 4 : KR-A4080 5 : KR-A5080
 Y : AAFES(Europe) X : Australia M : Other Areas C : CHINESE

△ indicates safety critical components.

KR-A2080/A3080/A4080/A5080

PARTS LIST

* New Parts
 Parts without **Parts No.** are not supplied.
 Les articles non mentionnés dans le **Parts No.** ne sont pas fournis.
 Teile ohne **Parts No.** werden nicht geliefert.

15

Ref. No	Add-ress	New Parts	Parts No.	Description	Desti-nation	Re-marks	
R43,44			RK73FB2A101J	CHIP R	100	J 1/10W	5
R45,46			RK73FB2A104J	CHIP R	100K	J 1/10W	5
R45,46			RK73FB2A104J	CHIP R	100K	J 1/10W	4
R47-50			RK73FB2A104J	CHIP R	100K	J 1/10W	5
R51,52			RK73FB2A473J	CHIP R	47K	J 1/10W	5
R53,54			RK73FB2A104J	CHIP R	100K	J 1/10W	
R59,60			RD14NB2E821J	RD	820	J 1/4W	
R61			RK73FB2A473J	CHIP R	47K	J 1/10W	
R62			RK73FB2A473J	CHIP R	47K	J 1/10W	4
R62			RK73FB2A473J	CHIP R	47K	J 1/10W	5
R66			RK73FB2A473J	CHIP R	47K	J 1/10W	4
R66			RK73FB2A473J	CHIP R	47K	J 1/10W	5
R67,68			RK73FB2A104J	CHIP R	100K	J 1/10W	4
R67,68			RK73FB2A104J	CHIP R	100K	J 1/10W	5
R69,70			RK73FB2A513J	CHIP R	51K	J 1/10W	4
R69,70			RK73FB2A513J	CHIP R	51K	J 1/10W	5
R71,72			RK73FB2A823J	CHIP R	82K	J 1/10W	4
R71,72			RK73FB2A823J	CHIP R	82K	J 1/10W	5
R73,74			RK73FB2A103J	CHIP R	10K	J 1/10W	4
R73,74			RK73FB2A103J	CHIP R	10K	J 1/10W	5
R75,76			RK73FB2A203J	CHIP R	20K	J 1/10W	4
R75,76			RK73FB2A203J	CHIP R	20K	J 1/10W	5
R79-81			RK73FB2A333J	CHIP R	33K	J 1/10W	5
R79-81			RK73FB2A333J	CHIP R	33K	J 1/10W	4
R82			RK73FB2A163J	CHIP R	16K	J 1/10W	4
R82			RK73FB2A163J	CHIP R	16K	J 1/10W	5
R83			RK73FB2A333J	CHIP R	33K	J 1/10W	4
R83			RK73FB2A333J	CHIP R	33K	J 1/10W	5
R84			RK73FB2A112J	CHIP R	1.1K	J 1/10W	4
R84			RK73FB2A112J	CHIP R	1.1K	J 1/10W	5
R85			RK73FB2A124J	CHIP R	120K	J 1/10W	4
R85			RK73FB2A124J	CHIP R	120K	J 1/10W	5
R86			RK73FB2A823J	CHIP R	82K	J 1/10W	4
R86			RK73FB2A823J	CHIP R	82K	J 1/10W	5
R87			RK73FB2A203J	CHIP R	20K	J 1/10W	4
R87			RK73FB2A203J	CHIP R	20K	J 1/10W	5
R88			RK73FB2A223J	CHIP R	22K	J 1/10W	4
R88			RK73FB2A223J	CHIP R	22K	J 1/10W	5
R89			RK73FB2A104J	CHIP R	100K	J 1/10W	4
R89			RK73FB2A104J	CHIP R	100K	J 1/10W	5
R90			RK73FB2A152J	CHIP R	1.5K	J 1/10W	4
R90			RK73FB2A152J	CHIP R	1.5K	J 1/10W	5
R91			RK73FB2A203J	CHIP R	20K	J 1/10W	4
R91			RK73FB2A203J	CHIP R	20K	J 1/10W	5
R92			RK73FB2A433J	CHIP R	43K	J 1/10W	4
R92			RK73FB2A433J	CHIP R	43K	J 1/10W	5
R93			RK73FB2A273J	CHIP R	27K	J 1/10W	4
R93			RK73FB2A273J	CHIP R	27K	J 1/10W	5
R94			RK73FB2A823J	CHIP R	82K	J 1/10W	4
R94			RK73FB2A823J	CHIP R	82K	J 1/10W	5
R95			RK73FB2A124J	CHIP R	120K	J 1/10W	4
R95			RK73FB2A124J	CHIP R	120K	J 1/10W	5
R96			RK73FB2A104J	CHIP R	100K	J 1/10W	4
R96			RK73FB2A104J	CHIP R	100K	J 1/10W	5
R97			RK73FB2A203J	CHIP R	20K	J 1/10W	4

L : Scandinavia K : USA P : Canada R : Mexico 2 : KR-A2080 3 : KR-A3080
 Y : PX(Far East, Hawaii) T : Europe E : Europe G : Germany 4 : KR-A4080 5 : KR-A5080
 Y : AAFES(Europe) X : Australia M : Other Areas C : CHINESE

△ indicates safety critical components.

* New Parts
 Parts without **Parts No.** are not supplied.
 Les articles non mentionnés dans le **Parts No.** ne sont pas fournis.
 Teile ohne **Parts No.** werden nicht geliefert.

16

Ref. No	Add-ress	New Parts	Parts No.	Description	Desti-nation	Re-marks	
R97			RK73FB2A203J	CHIP R	20K	J 1/10W	5
R98			RK73FB2A362J	CHIP R	3.6K	J 1/10W	4
R98			RK73FB2A362J	CHIP R	3.6K	J 1/10W	5
R99			RK73FB2A433J	CHIP R	43K	J 1/10W	4
R99			RK73FB2A433J	CHIP R	43K	J 1/10W	5
R100			RK73FB2A223J	CHIP R	22K	J 1/10W	4
R100			RK73FB2A223J	CHIP R	22K	J 1/10W	5
R101,102			RK73FB2A473J	CHIP R	47K	J 1/10W	4
R101,102			RK73FB2A473J	CHIP R	47K	J 1/10W	5
R103,104			RK73FB2A562J	CHIP R	5.6K	J 1/10W	
R105,106			RK73FB2A104J	CHIP R	100K	J 1/10W	
R107,108			RK73FB2A122J	CHIP R	1.2K	J 1/10W	
R109,110			RK73FB2A222J	CHIP R	2.2K	J 1/10W	4
R109,110			RK73FB2A222J	CHIP R	2.2K	J 1/10W	5
R111			RK73FB2A152J	CHIP R	1.5K	J 1/10W	
R112			RK73FB2A392J	CHIP R	3.9K	J 1/10W	
R113			RD14NB2E221J	RD	220	J 1/4W	
R117,118			RK73FB2A103J	CHIP R	10K	J 1/10W	
R120			RK73FB2A103J	CHIP R	10K	J 1/10W	
R121			RK73FB2A473J	CHIP R	47K	J 1/10W	
R122			RK73FB2A222J	CHIP R	2.2K	J 1/10W	
R125,126			RK73FB2A223J	CHIP R	22K	J 1/10W	
R131,132			RK73FB2A472J	CHIP R	4.7K	J 1/10W	
R145-148			RD14NB2E221J	RD	220	J 1/4W	
R153,154			RD14NB2E101J	RD	100	J 1/4W	
R161-164			RD14NB2E220J	RD	22	J 1/4W	
R165,166			RS14KB3DR22J	FL-PROOF RS	0.22	J 2W	3
R165,166			RS14KB3DR22J	FL-PROOF RS	0.22	J 2W	2
R165,166			RS14KB3DR68J	FL-PROOF RS	0.68	J 2W	5
R165,166			RS14KB3DR68J	FL-PROOF RS	0.68	J 2W	4
R167,168			RS14KB3DR68J	FL-PROOF RS	0.68	J 2W	4
R167,168			RS14KB3DR68J	FL-PROOF RS	0.68	J 2W	5
R169,170			RS14KB3DR22J	FL-PROOF RS	0.22	J 2W	3
R169,170			RS14KB3DR22J	FL-PROOF RS	0.22	J 2W	2
R169,170			RS14KB3DR68J	FL-PROOF RS	0.68	J 2W	5
R169,170			RS14KB3DR68J	FL-PROOF RS	0.68	J 2W	4
R171,172			RS14KB3DR68J	FL-PROOF RS	0.68	J 2W	4
R171,172			RS14KB3DR68J	FL-PROOF RS	0.68	J 2W	5
R173,174			RS14KB3DR7J	FL-PROOF RS	4.7	J 2W	
R175,176			RD14NB2E100J	RD	10	J 1/4W	2
R175,176			RD14NB2E100J	RD	10	J 1/4W	4
R175,176			RD14NB2E100J	RD	10	J 1/4W	3
R177,178			RS14KB3DR391J	FL-PROOF RS	390	J 2W	
R179,180			RD14NB2E392J	RD	3.9K	J 1/4W	3
R179,180			RD14NB2E392J	RD	3.9K	J 1/4W	2
R179,180			RD14NB2E682J	RD	6.8K	J 1/4W	5
R179,180			RD14NB2E682J	RD	6.8K	J 1/4W	4
R195			RS14KB3D181J	FL-PROOF RS	180	J 2W	
R198			RS14KB3D181J	FL-PROOF RS	180	J 2W	
R200			RK73FB2A332J	CHIP R	3.3K	J 1/10W	4
R200			RK73FB2A332J	CHIP R	3.3K	J 1/10W	5
R203			RD14NB2E3R3J	RD	3.3	J 1/4W	
R204,205			RK73FB2A103J	CHIP R	10K	J 1/10W	
R206			RK73FB2A101J	CHIP R	100	J 1/10W	
R207			RS14KB3D181J	FL-PROOF RS	180	J 2W	KPM 3

L : Scandinavia K : USA P : Canada R : Mexico 2 : KR-A2080 3 : KR-A3080
 Y : PX(Far East, Hawaii) T : Europe E : Europe G : Germany 4 : KR-A4080 5 : KR-A5080
 Y : AAFES(Europe) X : Australia M : Other Areas C : CHINESE

△ indicates safety critical components.

KR-A2080/A3080/A4080/A5080
 PARTS LIST

* New Parts
Parts without **Parts No.** are not supplied.
Les articles non mentionnés dans le **Parts No.** ne sont pas fournis.
Teile ohne **Parts No.** werden nicht geliefert.

15

Ref. No	Add-ress	New Parts	Parts No.	Description	Desti-nation	Re-marks
R207			RS14KB3D221J	FL-PROOF RS 220 J 2W	KPMCX	4
R207			RS14KB3D221J	FL-PROOF RS 220 J 2W	E	2
R207			RS14KB3D221J	FL-PROOF RS 220 J 2W	TE	3
R207			RS14KB3D271J	FL-PROOF RS 270 J 2W	TE	4
R207,208			RS14KB3D102J	FL-PROOF RS 1.0K J 2W	KPMC	5
R209			RS14KB3D151J	FL-PROOF RS 150 J 2W	KPMC	5
R209			RS14KB3D181J	FL-PROOF RS 180 J 2W		2
R209			RS14KB3D181J	FL-PROOF RS 180 J 2W		3
R209			RS14KB3D271J	FL-PROOF RS 270 J 2W		4
R210			RS14KB3D182J	FL-PROOF RS 1.8K J 2W	KPMCX	4
R210			RS14KB3D182J	FL-PROOF RS 1.8K J 2W	KPM	3
R210			RS14KB3D222J	FL-PROOF RS 2.2K J 2W	KPMC	5
R213			RK73FB2A163J	CHIP R 16K J 1/10W		
R214			RK73FB2A153J	CHIP R 15K J 1/10W		
R215			RD14NB2E682J	RD 6.8K J 1/4W		
R216			RD14NB2E101J	RD 100 J 1/4W		
R217			RD14NB2E470J	RD 47 J 1/4W	KPMCX	
R220			RS14KB3A103J	FL-PROOF RS 10K J 1W	KPMCX	
R223			RD14NB2E101J	RD 100 J 1/4W	TE	4
R223			RD14NB2E101J	RD 100 J 1/4W	TE	3
R223			RD14NB2E101J	RD 100 J 1/4W	E	2
R223			RD14NB2E220J	RD 22 J 1/4W	KPMCX	
R223			RD14NB2E220J	RD 22 J 1/4W	KPM	3
R225			RS14KB3A151J	FL-PROOF RS 150 J 1W	E	2
R231,232			RK73FB2A103J	CHIP R 10K J 1/10W	KPMCX	
R234			RK73FB2A103J	CHIP R 10K J 1/10W		
R235			RK73FB2A473J	CHIP R 47K J 1/10W		
R238,239			RK73FB2A112J	CHIP R 1.1K J 1/10W		
R240,241			RK73FB2A104J	CHIP R 100K J 1/10W		
R242,243			RK73FB2A221J	CHIP R 220 J 1/10W		4
R242,243			RK73FB2A221J	CHIP R 220 J 1/10W		5
R301,302			RK73FB2A223J	CHIP R 22K J 1/10W	TE	3
R301,302			RK73FB2A223J	CHIP R 22K J 1/10W	TE	4
R303			RK73FB2A473J	CHIP R 47K J 1/10W	TE	4
R303			RK73FB2A473J	CHIP R 47K J 1/10W	TE	3
R304,305			RK73FB2A101J	CHIP R 100 J 1/10W	TE	4
R304,305			RK73FB2A101J	CHIP R 100 J 1/10W	TE	3
R306			RK73FB2A222J	CHIP R 2.2K J 1/10W	TE	4
R306			RK73FB2A222J	CHIP R 2.2K J 1/10W	TE	3
R307-309			RK73FB2A101J	CHIP R 100 J 1/10W	TE	4
R307-309			RK73FB2A101J	CHIP R 100 J 1/10W	TE	3
R310			RK73FB2A103J	CHIP R 10K J 1/10W	TE	4
R310			RK73FB2A103J	CHIP R 10K J 1/10W	TE	3
R401-421			RK73FB2A101J	CHIP R 100 J 1/10W		
R422			RK73FB2A101J	CHIP R 100 J 1/10W	TE	3
R422			RK73FB2A101J	CHIP R 100 J 1/10W	TE	4
R423-427			RK73FB2A101J	CHIP R 100 J 1/10W	TE	3
R423-427			RK73FB2A101J	CHIP R 100 J 1/10W	TE	4
R441,442			RK73FB2A103J	CHIP R 10K J 1/10W		
R445			RK73FB2A104J	CHIP R 100K J 1/10W	TE	3
R445			RK73FB2A104J	CHIP R 100K J 1/10W	TE	4
R446			RK73FB2A104J	CHIP R 100K J 1/10W		
R447			RK73FB2A103J	CHIP R 10K J 1/10W	TE	4
R447			RK73FB2A103J	CHIP R 10K J 1/10W	TE	3
R448-450			RK73FB2A103J	CHIP R 10K J 1/10W		

L : Scandinavia K : USA P : Canada R : Mexico 2 : KR-A2080 3 : KR-A3080
Y : PX(Far East, Hawaii) T : Europe E : Europe G : Germany 4 : KR-A4080 5 : KR-A5080
Y : AAFES(Europe) X : Australia M : Other Areas C : CHINESE

▲ indicates safety critical components.

* New Parts
Parts without **Parts No.** are not supplied.
Les articles non mentionnés dans le **Parts No.** ne sont pas fournis.
Teile ohne **Parts No.** werden nicht geliefert.

16

Ref. No	Add-ress	New Parts	Parts No.	Description	Desti-nation	Re-marks
R451,452			RK73FB2A104J	CHIP R 100K J 1/10W		
R453			RK73FB2A101J	CHIP R 100 J 1/10W		
R456			RK73FB2A123J	CHIP R 12K J 1/10W		4
R456			RK73FB2A123J	CHIP R 12K J 1/10W		2
R457			RK73FB2A123J	CHIP R 12K J 1/10W		3
R457			RK73FB2A123J	CHIP R 12K J 1/10W	E	2
R457,459			RK73FB2A102J	CHIP R 1.0K J 1/10W		
R460			RK73FB2A103J	CHIP R 10K J 1/10W		
R461			RK73FB2A102J	CHIP R 1.0K J 1/10W		
R462			RK73FB2A104J	CHIP R 100K J 1/10W		
R463			RK73FB2A103J	CHIP R 10K J 1/10W		
R464			RK73FB2A102J	CHIP R 1.0K J 1/10W		
R465			RK73FB2A331J	CHIP R 330 J 1/10W		4
R465			RK73FB2A331J	CHIP R 330 J 1/10W		5
R465			RK73FB2A331J	CHIP R 330 J 1/10W		3
R466,467			RK73FB2A104J	CHIP R 100K J 1/10W		3
R466,467			RK73FB2A104J	CHIP R 100K J 1/10W		4
R466,467			RK73FB2A104J	CHIP R 100K J 1/10W		5
R468			RK73FB2A331J	CHIP R 330 J 1/10W		3
R468			RK73FB2A331J	CHIP R 330 J 1/10W		4
R468			RK73FB2A331J	CHIP R 330 J 1/10W		3
R468			RK73FB2A331J	CHIP R 330 J 1/10W		5
R469,470			RK73FB2A104J	CHIP R 100K J 1/10W		3
R469,470			RK73FB2A104J	CHIP R 100K J 1/10W		4
R469,470			RK73FB2A104J	CHIP R 100K J 1/10W		5
R471			RD14NB2E100J	RD 10 J 1/4W		4
R471			RD14NB2E100J	RD 10 J 1/4W		5
R473			RK73FB2A103J	CHIP R 10K J 1/10W	MC	
R475-478			RK73FB2A103J	CHIP R 10K J 1/10W		
R479-482			RK73FB2A101J	CHIP R 100 J 1/10W		
R483,484			RD14NB2E221J	RD 220 J 1/4W		
R490			RK73FB2A103J	CHIP R 10K J 1/10W		
R491			RK73FB2A332J	CHIP R 3.3K J 1/10W	TE	
R494			RK73FB2A104J	CHIP R 100K J 1/10W	E	2
VR1,2			R12-1616-05	TRIMMING POT.(1K)	KPMCX	4
VR1,2			R12-1617-05	TRIMMING POT.(2.2K)	KPMC	5
VR1,2			R12-1617-05	TRIMMING POT.(2.2K)		2
VR1,2			R12-1617-05	TRIMMING POT.(2.2K)		3
VR1,2			R12-1617-05	TRIMMING POT.(2.2K)	TE	4
W301-303			R92-0670-05	CHIP R 0 OHM		4
W301-303			R92-0670-05	CHIP R 0 OHM		5
W304			R92-0670-05	CHIP R 0 OHM		
W305			R92-0670-05	CHIP R 0 OHM		4
W305			R92-0670-05	CHIP R 0 OHM		5
W521-523			R92-0670-05	CHIP R 0 OHM		
W524			R92-0679-05	CHIP R 0 OHM		
W525			R92-0670-05	CHIP R 0 OHM		
W526-528			R92-0679-05	CHIP R 0 OHM		
W529			R92-0670-05	CHIP R 0 OHM		
K1,2		*	S76-0051-05	MAGNETIC RELAY		
S1			S31-2136-05	SLIDE SWITCH (POWER TYPE)	KPMCX	
S401-404			S70-0031-05	TACT SWITCH		
S405			S70-0031-05	TACT SWITCH		4
S405			S70-0031-05	TACT SWITCH		5

L : Scandinavia K : USA P : Canada R : Mexico 2 : KR-A2080 3 : KR-A3080
Y : PX(Far East, Hawaii) T : Europe E : Europe G : Germany 4 : KR-A4080 5 : KR-A5080
Y : AAFES(Europe) X : Australia M : Other Areas C : CHINESE

▲ indicates safety critical components.

KR-A2080/A3080/A4080/A5080

PARTS LIST

* New Parts
 Parts without **Parts No.** are not supplied.
 Les articles non mentionnés dans le **Parts No.** ne sont pas fournis.
 Teile ohne **Parts No.** werden nicht geliefert.

17

Ref. No	Add-ress	New Parts	Parts No.	Description	Desti-nation	Re-marks
S406,407			S70-0031-05	TACT SWITCH		
S408			S70-0031-05	TACT SWITCH		3
S408			S70-0031-05	TACT SWITCH		4
S408			S70-0031-05	TACT SWITCH		5
S409-412			S70-0031-05	TACT SWITCH		
S413			S70-0031-05	TACT SWITCH		4
S413			S70-0031-05	TACT SWITCH		5
S414-429			S70-0031-05	TACT SWITCH		
S430			T99-0571-05	ROTARY ENCODER		
S431			T99-0559-05	ROTARY ENCODER		
D1,2			HZS6.8N(B2)	ZENER DIODE		
D1,2			RD6.8ES(B2)	ZENER DIODE		
D3,4			HZS8.2N(B2)	ZENER DIODE		
D3,4			RD8.2ES(B2)	ZENER DIODE		
D5			HSS104	DIODE		
D5			1SS133	DIODE		
D7,8			HSS104	DIODE		
D7,8			1SS133	DIODE		
D9-11			HSS104A	DIODE		
D9-11			1SS131	DIODE		
D12			HZS5.1N(B2)	ZENER DIODE		
D12			RD5.1ES(B2)	ZENER DIODE		
D13,14			HSS104A	DIODE		
D13,14			1SS131	DIODE		
D15-18			HSS104	DIODE		
D15-18			1SS133	DIODE		
D19,20			HZS8.2N(B2)	ZENER DIODE		
D19,20			RD8.2ES(B2)	ZENER DIODE		
D21-28			HSS104	DIODE		
D21-28			1SS133	DIODE		
D29-32			HSS104	DIODE		4
D29-32			HSS104	DIODE		5
D29-32			1SS133	DIODE		4
D29-32			1SS133	DIODE		5
D33			MA111	DIODE		4
D33			MA111	DIODE		5
D34			HSS104	DIODE		
D34			1SS133	DIODE		
D35			MA111	DIODE		4
D35			MA111	DIODE		5
D36			HSS104	DIODE		
D36			1SS133	DIODE		
D37,38			MA111	DIODE		
D39-42			HSS104	DIODE		
D39-42			1SS133	DIODE		
D51			D3SBA20F03	DIODE		2
D51			D3SBA20F03	DIODE		3
D51			D5SBA20F03	DIODE		5
D51			D5SBA20F03	DIODE		4
D52-55			S5688B	DIODE		
D52-55			1SR139-100	DIODE		
D56			HZS11N(B2)	ZENER DIODE		
D56			RD11ES(B2)	ZENER DIODE		
D57-60			S5688B	DIODE	KPMCX	

L : Scandinavia K : USA P : Canada R : Mexico 2 : KR-A2080 3 : KR-A3080
 Y : PX(Far East, Hawaii) T : Europe E : Europe G : Germany 4 : KR-A4080 5 : KR-A5080
 V : AAFES(Europe) X : Australia M : Other Areas C : CHINESE

⚠ indicates safety critical components.

* New Parts
 Parts without **Parts No.** are not supplied.
 Les articles non mentionnés dans le **Parts No.** ne sont pas fournis.
 Teile ohne **Parts No.** werden nicht geliefert.

18

Ref. No	Add-ress	New Parts	Parts No.	Description	Desti-nation	Re-marks
D57-60			1SR139-100	DIODE	KPMCX	
D61,62			HZS16N(B2)	ZENER DIODE		
D61,62			RD16ES(B2)	ZENER DIODE		
D63,64			S5688B	DIODE	KPMCX	
D63,64			1SR139-100	DIODE	KPMCX	
D65			HZS5.6N(B)	ZENER DIODE	KPMCX	
D65			RD5.6ES(B)	ZENER DIODE	KPMCX	
D66			HSS104	DIODE	KPMCX	
D66			1SS133	DIODE	KPMCX	
D67,68			HSS104	DIODE	KPMCX	2
D67,68			1SS133	DIODE	E	2
D69			HZS8.2N(B2)	ZENER DIODE	E	2
D69			RD8.2ES(B2)	ZENER DIODE	E	2
D70			HSS104A	DIODE		
D70			1SS131	DIODE		
D301			HSS104	DIODE		
D301			1SS133	DIODE		
D401-404			HSS104	DIODE		
D401-404			1SS133	DIODE		
D405-410			HSS104	DIODE		4
D405-410			HSS104	DIODE		5
D405-410			1SS133	DIODE		3
D405-410			1SS133	DIODE		4
D405-410			1SS133	DIODE		5
D405-410			1SS133	DIODE		3
D412-419			HSS104A	DIODE		
D412-419			1SS131	DIODE		
D420			HSS104A	DIODE	MCTEX	
D420			1SS131	DIODE	MCTEX	
D421			HSS104A	DIODE	X	
D421			HSS104A	DIODE	E	2
D421			1SS131	DIODE	X	
D421			1SS131	DIODE	E	2
D422			HSS104A	DIODE	TE	4
D422			HSS104A	DIODE	TE	3
D422			1SS131	DIODE	TE	4
D422			1SS131	DIODE	TE	3
D424			HSS104A	DIODE	MC	
D424			1SS131	DIODE	MC	
D425			HZS5.6N(B)	ZENER DIODE		
D425			RD5.6ES(B)	ZENER DIODE		
D426,427			MA111	DIODE	KP	
ED401			FIP10BM6R	INDICATOR TUBE		
IC1			NJM4580ED	ANALOGUE IC		
IC2			XRU4052BC	MOS-IC		
IC3			HD14066BP	IC(QUADRUPLE ANALOG SWITCH)		4
IC4			HD14066BP	IC(QUADRUPLE ANALOG SWITCH)		5
IC4			HD14066BP	IC(QUADRUPLE ANALOG SWITCH)		4
IC5			NJM4565M	IC(OP AMP X2)		4
IC6			HD14066BP	IC(QUADRUPLE ANALOG SWITCH)		5
IC6			HD14066BP	IC(QUADRUPLE ANALOG SWITCH)		4
IC7-10			NJM4565M	IC(OP AMP X2)		5
IC7-10			NJM4565M	IC(OP AMP X2)		5
IC11			TDA7315	ANALOGUE IC		
IC12			TA78057S	IC(VOLTAGE REGULATOR/+5.75V)	E	2

L : Scandinavia K : USA P : Canada R : Mexico 2 : KR-A2080 3 : KR-A3080
 Y : PX(Far East, Hawaii) T : Europe E : Europe G : Germany 4 : KR-A4080 5 : KR-A5080
 V : AAFES(Europe) X : Australia M : Other Areas C : CHINESE

⚠ indicates safety critical components.

PARTS LIST

KR-A2080/A3080/A4080/A5080

* New Parts
Parts without **Parts No.** are not supplied.
Les articles non mentionnés dans le **Parts No.** ne sont pas fournis.
Teile ohne **Parts No.** werden nicht geliefert.

19

Ref. No	Add-ress	New Parts	Parts No.	Description	Desti-nation	Re-marks
IC301			SAA6579	ANALOGUE IC	TE	4
IC301			SAA6579	ANALOGUE IC	TE	3
IC302			LC6543H-4D68	MI-COM IC	TE	4
IC302			LC6543H-4D68	MI-COM IC	TE	3
IC401			S-806D-Z	ANALOGUE IC		
IC402			UPD78043AGF040	MI-COM IC	KPMCX	
IC402			UPD78043AGF040	MI-COM IC		2
IC402		*	UPD78044AGF162	MI-COM IC	TE	4
IC402		*	UPD78044AGF162	MI-COM IC	TE	3
Q1,2			2SC2878(B)	TRANSISTOR		
Q3,4			DTC124ES	DIGITAL TRANSISTOR		4
Q3,4			DTC124ES	DIGITAL TRANSISTOR		5
Q3,4			UN4212	TRANSISTOR		4
Q3,4			UN4212	TRANSISTOR		5
Q5			2SA1048(Y,GR)	TRANSISTOR		
Q5			2SA1309A(Q,R)	TRANSISTOR		
Q6			2SA1586(Y,GR)	TRANSISTOR		
Q6		*	2SA1611(M5,M6)	TRANSISTOR		
Q7,8			2SC4213(B)	TRANSISTOR		
Q9			2SC4116(Y,GR)	TRANSISTOR		
Q9			2SC4177(L5,L6)	TRANSISTOR		
Q10			2SC2458(Y,GR)	TRANSISTOR		
Q10			2SC3311A(Q,R)	TRANSISTOR		
Q11-14			2SA992(F,E)	TRANSISTOR		
Q15-18			2SC1845(F,E)	TRANSISTOR		
Q19,20			2SA1123(R,S)	TRANSISTOR		
Q21,22			2SC4137F50(V,W)	TRANSISTOR		
Q23,24			2SD2222	TRANSISTOR	KPMC	5
Q23,24			2SD2222	TRANSISTOR	TE	4
Q23,24			2SD2390	TRANSISTOR	KPMCX	4
Q23,24			2SD2493	TRANSISTOR		2
Q23,24			2SD2493	TRANSISTOR		3
Q25,26			2SB1470	TRANSISTOR	KPMC	5
Q25,26			2SB1470	TRANSISTOR	TE	4
Q25,26			2SB1560	TRANSISTOR	KPMCX	4
Q25,26			2SB1624	TRANSISTOR		2
Q25,26			2SB1624	TRANSISTOR		3
Q27-30			2SC1845(F,E)	TRANSISTOR		
Q31			2SA1048(Y,GR)	TRANSISTOR		
Q31			2SA1309A(Q,R)	TRANSISTOR		
Q32			2SA992(F,E)	TRANSISTOR		
Q33,34			2SC2003(L,K)	TRANSISTOR		
Q35			2SA1048(Y,GR)	TRANSISTOR		
Q35			2SA1309A(Q,R)	TRANSISTOR		
Q36			2SA1586(Y,GR)	TRANSISTOR		
Q36		*	2SA1611(M5,M6)	TRANSISTOR		
Q37,38			2SC4213(B)	TRANSISTOR		
Q51			2SD2061	TRANSISTOR		
Q52,53			2SC4116(Y,GR)	TRANSISTOR		
Q52,53			2SC4177(L5,L6)	TRANSISTOR		
Q54			2SD2061	TRANSISTOR		
Q55			2SA1048(Y,GR)	TRANSISTOR		
Q55			2SA1309A(Q,R)	TRANSISTOR		
Q56			2SA1586(Y,GR)	TRANSISTOR		
Q56		*	2SA1611(M5,M6)	TRANSISTOR		

L : Scandinavia K : USA P : Canada R : Mexico 2 : KR-A2080 3 : KR-A3080
Y : PX(Far East, Hawaii) T : Europe E : Europe G : Germany 4 : KR-A4080 5 : KR-A5080
Y : AAFES(Europe) X : Australia M : Other Areas C : CHINESE

△ indicates safety critical components.

* New Parts
Parts without **Parts No.** are not supplied.
Les articles non mentionnés dans le **Parts No.** ne sont pas fournis.
Teile ohne **Parts No.** werden nicht geliefert.

20

Ref. No	Add-ress	New Parts	Parts No.	Description	Desti-nation	Re-marks
Q57			2SA1534A	TRANSISTOR		
Q58			2SA992(F,E)	TRANSISTOR	KPMCX	
Q401			2SC4116(Y,GR)	TRANSISTOR		
Q401			2SC4177(L5,L6)	TRANSISTOR		
Q402			2SC2458(Y,GR)	TRANSISTOR		
Q402			2SC3311A(Q,R)	TRANSISTOR		
Q403			2SA1586(Y,GR)	TRANSISTOR	MC	
Q403		*	2SA1611(M5,M6)	TRANSISTOR	MC	
A401	2A	*	W02-2551-05	ELECTRIC CIRCUIT MODULE		3
A401	2A	*	W02-2551-05	ELECTRIC CIRCUIT MODULE		4
A401	2A	*	W02-2551-05	ELECTRIC CIRCUIT MODULE		5

L : Scandinavia K : USA P : Canada R : Mexico 2 : KR-A2080 3 : KR-A3080
Y : PX(Far East, Hawaii) T : Europe E : Europe G : Germany 4 : KR-A4080 5 : KR-A5080
Y : AAFES(Europe) X : Australia M : Other Areas C : CHINESE

△ indicates safety critical components.

KR-A2080/A3080/A4080/A5080

PARTS LIST

KR-A2080/A3080/A4080/A5080

SPECIFICATIONS

KR-A3080

Audio section

Rated power output at the STEREO operation

50 watts per channel minimum RMS, both channels driven at 8 Ω, from 30 Hz to 20,000 Hz with no more than 0.09 % total harmonic distortion. (FTC)

Total harmonic distortion 0.03 % (1 kHz, 25 W, 8 Ω)
 Signal to noise ratio (IHF'66)
 PHONO (MM) 75 dB
 LINE (CD, VIDEO, TAPE) 93 dB
 Input sensitivity / impedance
 PHONO (MM) 2.5 mV / 47 kΩ
 LINE (CD, VIDEO, TAPE) 200 mV / 47 kΩ
 Tone controls
 BASS ± 8 dB (at 150 Hz)
 TREBLE ± 8 dB (at 10 kHz)
 LOUDNESS control at - 30 dB VOLUME level
 + 6 dB (150 Hz)

FM Tuner section

Tuning frequency range 87.5 MHz ~ 108 MHz
 Usable sensitivity
 MONO 1.4 μV (75 Ω) / 14.2 dBf
 (75 kHz dev., S/N 30 dB)
 50 dB quieting sensitivity
 STEREO 44 μV (75 Ω) / 44.2dBf
 (75 kHz dev.)
 Total harmonic distortion (1 kHz)
 MONO 0.6 % (65.2 dBf input)
 STEREO 0.7 % (65.2 dBf input)
 Signal to noise ratio (1 kHz, 75 kHz dev.)
 MONO 75 dB (65.2 dBf input)
 STEREO 68 dB (65.2 dBf input)
 Stereo separation
 1 kHz 40 dB
 Selectivity (±400 kHz) 50 dB
 Frequency response 30 Hz ~ 15 kHz, + 0.5 dB, - 3.0 dB

AM Tuner section

Tuning frequency range 530 kHz ~ 1,700 kHz
 Usable sensitivity (30 % mod., S/N 20 dB)
 20 μV / (560 μV / m)
 Total harmonic distortion 0.7 %
 Signal to noise ratio (30 % mod., 1 mV input) 48 dB
 Selectivity 30 dB

General

Power consumption 130 W
 AC outlet
 SWITCHED 2: (total 150 W, 1.25 A max.)
 Dimensions W:440 mm (17-5/16")
 H:127 mm (5")
 D:380 mm (14-15/16")
 Weight (net) 6.9 kg (15.2 lb)

KR-A2080

Audio section

Rated power output at the STEREO operation
 (DIN/IEC) from 63 Hz to 12,500 Hz
 0.7% T.H.D. at 4 Ω 50 W + 50 W
 Total harmonic distortion 0.03 % (1 kHz, 25 W, 4 Ω)
 Signal to noise ratio (IEC)
 PHONO (MM) 52 dB
 LINE (CD, VIDEO, TAPE) 53 dB
 Input sensitivity / impedance
 PHONO (MM) 2.5 mV / 47 kΩ
 LINE (CD, VIDEO, TAPE) 200 mV / 47kΩ
 Tone controls
 BASS ± 8 dB (at 150 Hz)
 TREBLE ± 8 dB (at 10 kHz)
 LOUDNESS control at - 30 dB VOLUME level
 + 6 dB (150 Hz)

FM Tuner section

Tuning frequency range 87.5 MHz~108 MHz
 Usable sensitivity (DIN)
 MONO 1.3 μV (75 Ω) / 13.5 dBf
 (40 kHz dev., S/N 26 dB)
 STEREO 50 μV (75 Ω) / 45.2 dBf
 (46 kHz dev., S/N 46 dB)
 Total harmonic distortion at 1 kHz (DIN)
 MONO 0.2% (65.2 dBf input)
 STEREO 0.7% (65.2 dBf input)
 Signal to noise ratio (DIN weighted at 1 kHz, 40 kHz dev.)
 MONO 65 dB (65.2 dBf input)
 STEREO 58 dB (65.2 dBf input)
 Selectivity (DIN ± 300 kHz) 64 dB
 Stereo separation (DIN)
 1 kHz 33 dB
 Frequency response 30 Hz~15 kHz, + 0.5 dB, - 3.0 dB

AM Tuner section

Tuning frequency range 531 kHz ~ 1,602 kHz
 Usable sensitivity
 (30% mod., S/N 20 dB) 20 μV / (560 μV / m)
 Total harmonic distortion 0.7%
 Signal to noise ratio
 (at 30% mod. 1mV input) 48 dB
 Selectivity 30 dB

General

Power consumption 130 W
 AC outlet
 SWITCHED 2: (total 90 W max)
 Dimensions W:440 mm
 H:127 mm
 D:380 mm
 Weight (net) 6.7 kg

KR-A2080/A3080/A4080/A5080

SPECIFICATIONS

KR-A5080

Audio section

Rated power output at the STEREO operation

100 watts per channel minimum RMS, both channels driven at 8 Ω , from 20 Hz to 20,000 Hz with no more than 0.09 % total harmonic distortion. (FTC)

Total harmonic distortion 0.03 % (1 kHz, 50 W, 8 Ω)
Signal to noise ratio (IHF'66)
PHONO (MM) 75 dB
LINE (AUX, CD, VIDEO, TAPE 1, TAPE 2) 93 dB
Input sensitivity / impedance
PHONO (MM) 2.5 mV / 47 k Ω
LINE (AUX, CD, VIDEO, TAPE 1, TAPE 2) .. 200 mV / 47 k Ω
Tone controls
BASS \pm 8 dB (at 150 Hz)
TREBLE \pm 8 dB (at 10 kHz)
LOUDNESS control at - 30 dB VOLUME level
..... + 6 dB (150 Hz)

FM Tuner section

Tuning frequency range 87.5 MHz ~ 108 MHz
Usable sensitivity
MONO 1.4 μ V (75 Ω) / 14.2 dBf
(75 kHz dev., S/N 30 dB)
50 dB quieting sensitivity
STEREO 44 μ V (75 Ω) / 44.2dBf
(75 kHz dev.)
Total harmonic distortion (1 kHz)
MONO 0.6 % (65.2 dBf input)
STEREO 0.7 % (65.2 dBf input)
Signal to noise ratio (1 kHz, 75 kHz dev.)
MONO 75 dB (65.2 dBf input)
STEREO 68 dB (65.2 dBf input)
Stereo separation
1 kHz 40 dB
Selectivity (\pm 400 kHz) 50 dB
Frequency response 30 Hz ~15 kHz, + 0.5 dB, - 3.0 dB

AM Tuner section

Tuning frequency range 530 kHz ~ 1,700 kHz
Usable sensitivity (30 % mod., S/N 20 dB)
..... 20 μ V / (560 μ V / m)
Total harmonic distortion 0.7 %
Signal to noise ratio (30 % mod., 1 mV input) 48 dB
Selectivity 30 dB

General

Power consumption 2.5 A
AC outlet
SWITCHED 2: (total 150 W, 1.25 A max.)
Dimensions W:440 mm (17-5/16")
H:127 mm (5")
D:380 mm (14-15/16")
Weight (net) 8.7 kg (19.2 lb)

KR-A4080

Audio section

Rated power output at the STEREO operation

80 watts per channel minimum RMS, both channels driven at 8 Ω , from 20 Hz to 20,000 Hz with no more than 0.09 % total harmonic distortion. (FTC)

Total harmonic distortion 0.03 % (1 kHz, 40 W, 8 Ω)
Signal to noise ratio (IHF'66)
PHONO (MM) 75 dB
LINE (AUX, CD, VIDEO, TAPE 1, TAPE 2) 93 dB
Input sensitivity / impedance
PHONO (MM) 2.5 mV / 47 k Ω
LINE (AUX, CD, VIDEO, TAPE 1, TAPE 2) .. 200 mV / 47 k Ω
Tone controls
BASS \pm 8 dB (at 150 Hz)
TREBLE \pm 8 dB (at 10 kHz)
LOUDNESS control at - 30 dB VOLUME level
..... + 6 dB (150 Hz)

FM Tuner section

Tuning frequency range 87.5 MHz ~ 108 MHz
Usable sensitivity
MONO 1.4 μ V (75 Ω) / 14.2 dBf
(75 kHz dev., S/N 30 dB)
50 dB quieting sensitivity
STEREO 44 μ V (75 Ω) / 44.2dBf
(75 kHz dev.)
Total harmonic distortion (1 kHz)
MONO 0.6 % (65.2 dBf input)
STEREO 0.7 % (65.2 dBf input)
Signal to noise ratio (1 kHz, 75 kHz dev.)
MONO 75 dB (65.2 dBf input)
STEREO 68 dB (65.2 dBf input)
Stereo separation
1 kHz 40 dB
Selectivity (\pm 400 kHz) 50 dB
Frequency response 30 Hz ~15 kHz, + 0.5 dB, - 3.0 dB

AM Tuner section

Tuning frequency range 530 kHz ~ 1,700 kHz
Usable sensitivity (30 % mod., S/N 20 dB)
..... 20 μ V / (560 μ V / m)
Total harmonic distortion 0.7 %
Signal to noise ratio (30 % mod., 1 mV input) 48 dB
Selectivity 30 dB

General

Power consumption 190 W
AC outlet
SWITCHED 2: (total 150 W, 1.25 A max.)
Dimensions W:440 mm (17-5/16")
H:127 mm (5")
D:380 mm (14-15/16")
Weight (net) 8.4 kg (18.5 lb)

KENWOOD follows a policy of continuous advancements in development.
For this reason specifications may be changed without notice.

Note:

Component and circuitry are subject to modification to insure best operation under differing local conditions. This manual is based on Europe (E) standard, and provides information on regional circuit modification through use of alternate schematic diagrams, and information on regional component variations through use of parts list.

KENWOOD CORPORATION

14-6, Dogenzaka 1-chome, Shibuya-ku, Tokyo, 150 Japan

KENWOOD SERVICE CORPORATION

P.O. BOX 22745, 2201 East Dominguez St., Long Beach, CA 90801-5745, U.S.A.

AUDIO-VIDEO SURROUND RECEIVER

KR-V7080/V8080

SERVICE MANUAL

KENWOOD

HA 3513

© 1996-3/B51-5162-00 (K/K) 3823

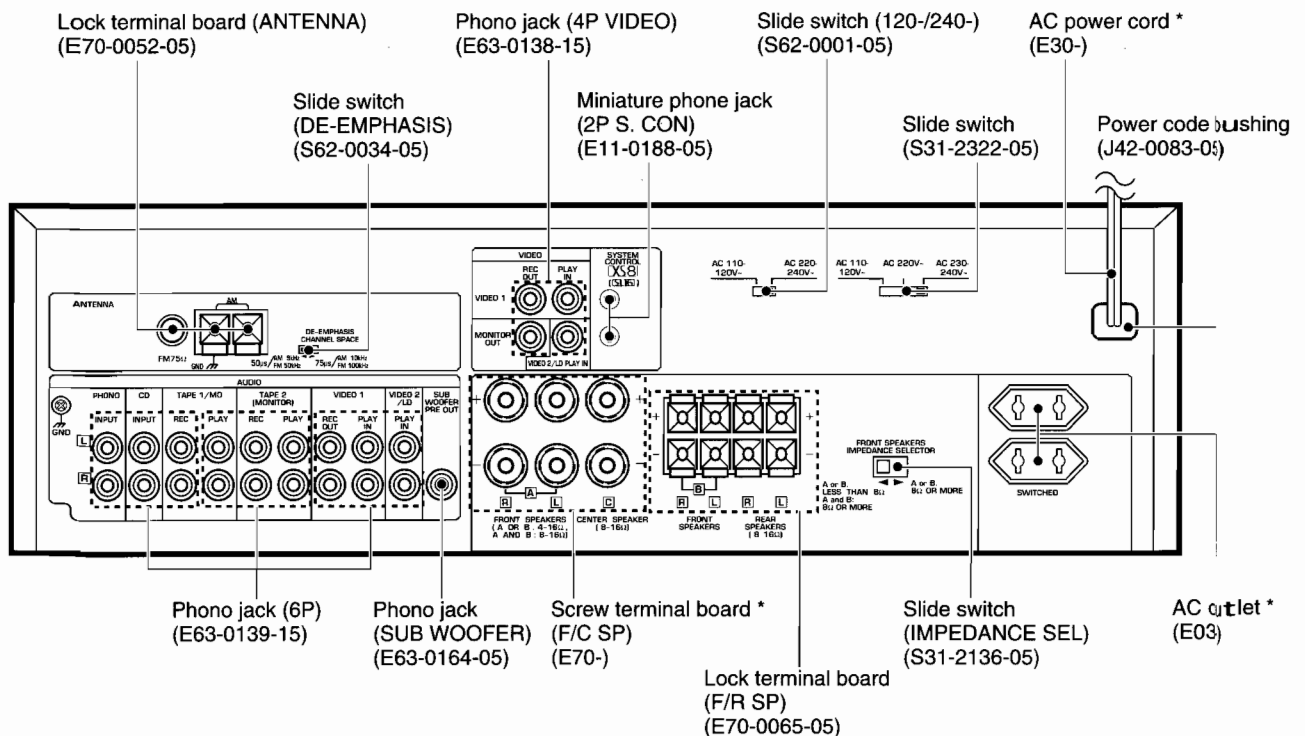
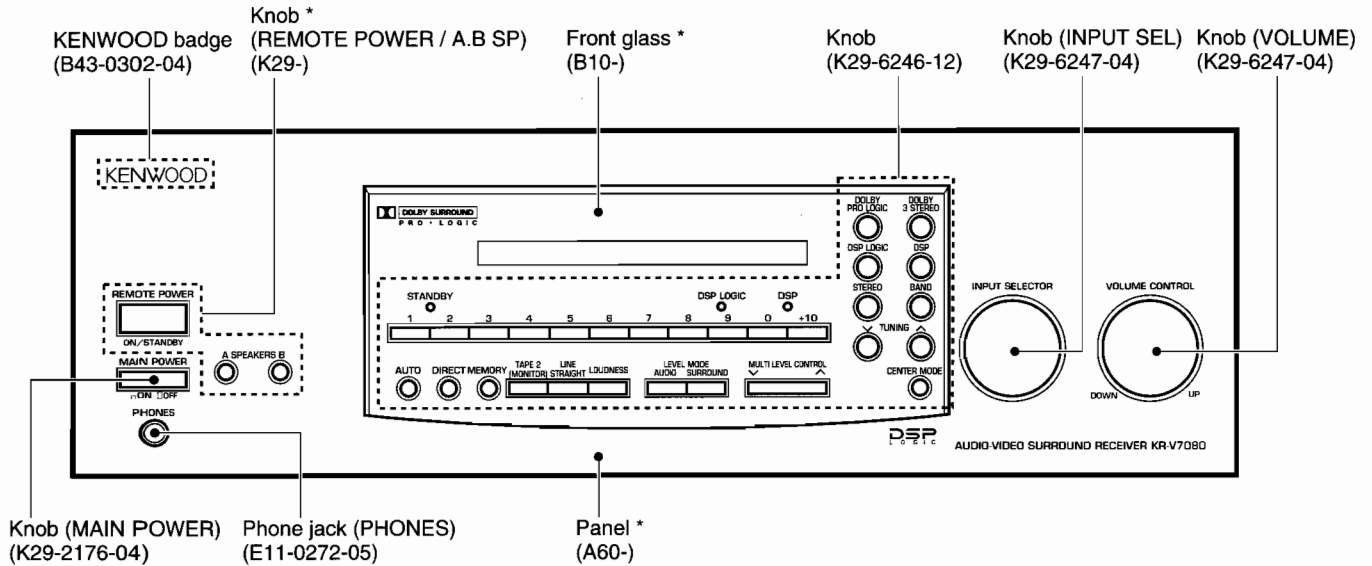

Illustration is KR-V7080.

* Refer to parts list on page 44.

KR-V7080/V8080

CONTENTS / ACCESSORIES

Contents

CONTENTS / ACCESSORIES	2	PC BOARD	18
CONTROLS	3	SCHEMATIC DIAGRAM	23
BLOCK DIAGRAM	5	EXPLODED VIEW (UNIT).....	43
CIRCUIT DESCRIPTION	6	PARTS LIST.....	44
ADJUSTMENT	16	SPECIFICATIONS	53
WIRING DIAGRAM	17		

Accessories

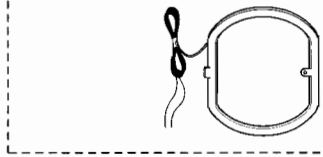
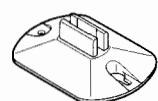
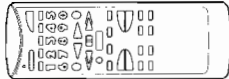
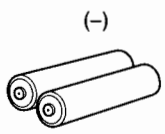
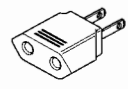
<p>FM indoor antenna(1) (T90-0810-05)</p>	<p>AM loop antenna ass'y(1) (T90-0195-05)</p>	<p>Loop antenna stand (J19-3645-05)</p>
		
<p>Remote control unit(1) (A70-1042-05) : RC-R0803 for K,P,Y,X,M,C (A70-1042-05) : RC-R0803 for T,E BATTERY COVER : (A09-0169-08)</p>	<p>Batteries (R6/AA)(2)</p>	<p>AC plug adaptor(1) (E03-0115-05) : M only</p>
	<p>(-)</p> 	

KR-V7080/V8080

CONTROLS

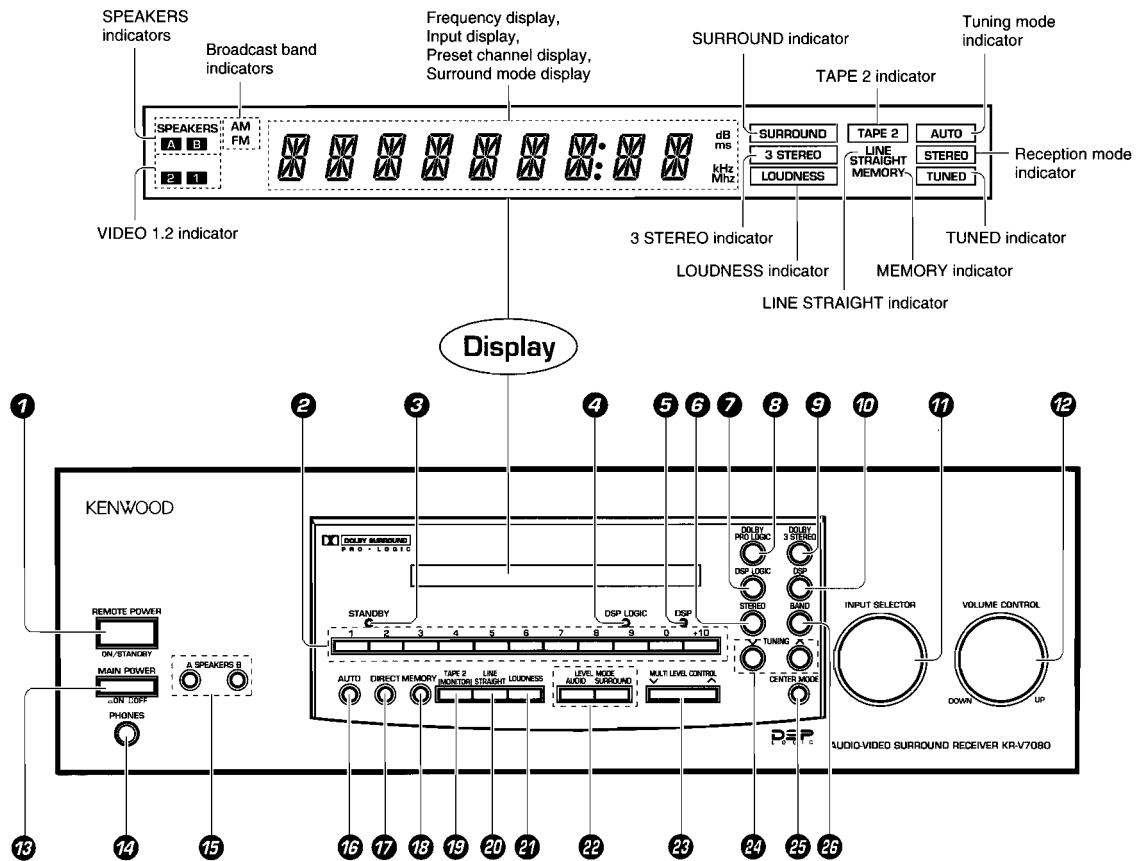

① REMOTE POWER key

Press to switch over the STANDBY/ON modes when the MAIN POWER is ON.

② Numeric keys

③ STANDBY indicator

④ DSP LOGIC indicator

Lights when the DSP LOGIC mode is ON.

⑤ DSP indicator

Lights when the DSP presence mode is ON.

⑥ STEREO key

Press to cancel the surround modes.

⑦ DSP LOGIC key

⑧ DOLBY PRO LOGIC key

⑨ DOLBY 3 STEREO key

⑩ DSP key

⑪ INPUT SELECTOR Knob

Turn to select the input sources.

⑫ VOLUME CONTROL Knob

⑬ MAIN POWER switch

Press to switch the main power ON/OFF.

⑭ PHONES jack

Used for headphone listening.

⑮ SPEAKERS A/B keys

Press to select the A and/or B speaker systems.

⑯ AUTO key

Press for select the auto tuning mode.

⑰ DIRECT key

Press for direct station tuning based on numerical input.

⑱ MEMORY key

Press to preset a station in the memory.

⑲ TAPE 2(MONITOR) key

Press to monitor the sound being recorded.

⑳ LINE STRAIGHT key

Press to listen to a source with high quality sound.

㉑ LOUDNESS key

Press to enhance low frequencies.

㉒ LEVEL MODE (AUDIO, SURROUND) keys

AUDIO key :

Press when adjusting the tone.

SURROUND key :

Press when adjusting the surround modes.

㉓ MULTI LEVEL CONTROL key

Press to adjust the tone or surround mode setting.

㉔ TUNING keys

Press to tune broadcast stations.

㉕ CENTER MODE key

Press to select the center mode in the DOLBY PRO LOGIC surround mode.

㉖ BAND key

Press to switch the broadcast band.

STANDBY mode of REMOTE POWER key

When the power cord of this system is plugged in to a power outlet and the MAIN POWER switch is pressed to ON, the STANDBY indicator lights up regardless of the REMOTE POWER key setting. This indicates that a small amount of current is being supplied to the unit to back up the memory contents. This mode is referred to as the Standby mode. While the STANDBY indicator is lit, the power of the system can also be switched ON/OFF from the remote control unit.

KR-V7080/V8080

REMOTE CONTROL OPERATION

The remote control unit provided with unit functions in the following two modes so that it can be used to control other KENWOOD system components as well as video components from other manufacturers.

KENWOOD component control mode This mode is used to control the KENWOOD source components including cassette decks and a CD player. (The controlled components must be connected to this unit through system control cords.)

Video component control mode This mode allows to control the basic operations of video components from KENWOOD as well as other manufacturers.

Some of the keys act in different ways depending on the modes described above. Therefore, be sure to adjust the required mode before pressing these keys.

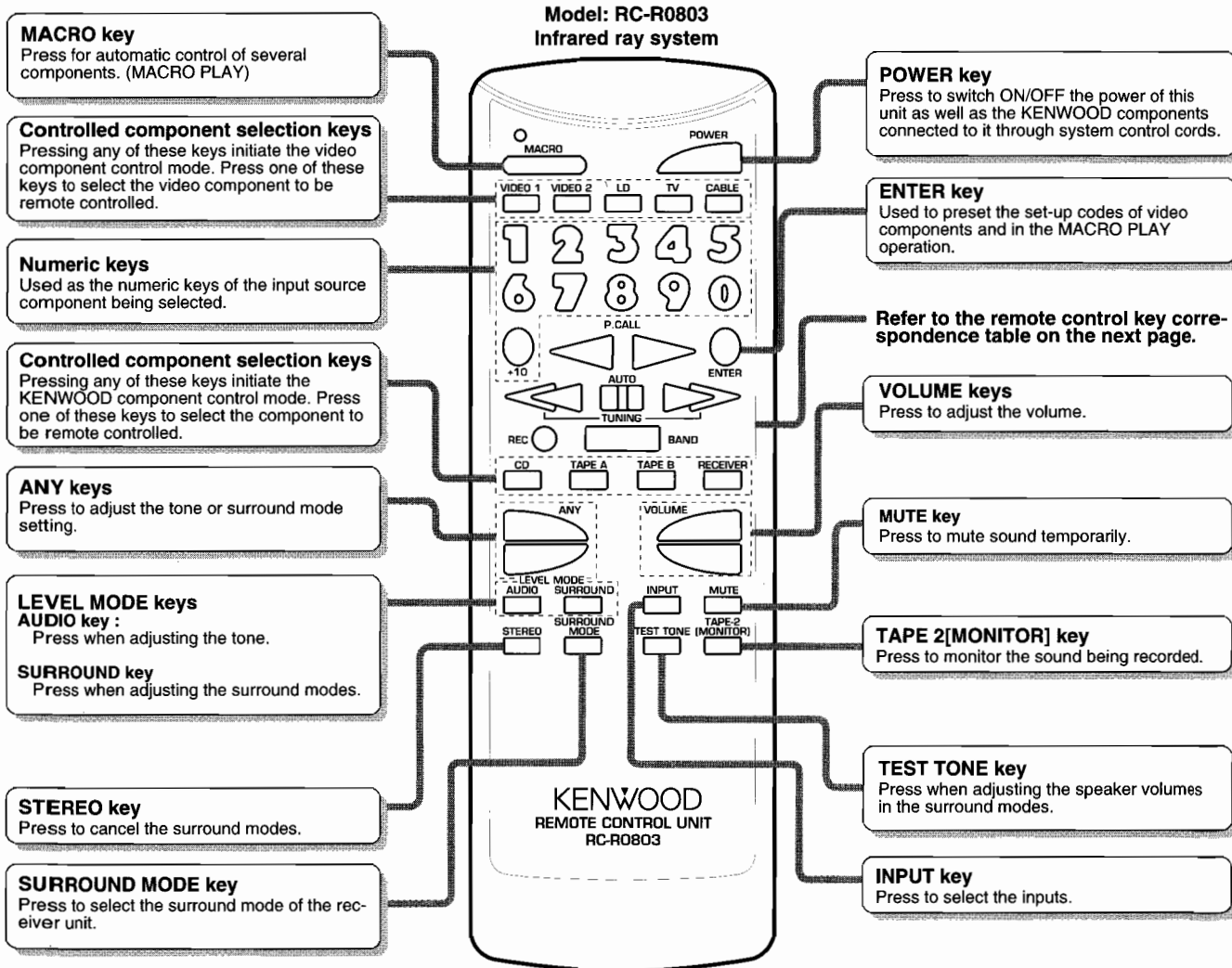

Loading batteries

① Remove the cover.

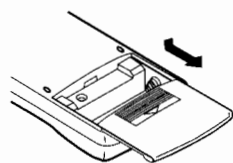

② Insert batteries.

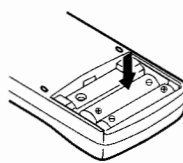

③ Close the cover.

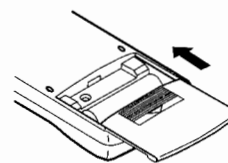

• Insert two AA-size (R6 / SUM-3) batteries as indicated by the polarity marking.

KR-V7080/V8080

BLOCK DIAGRAM

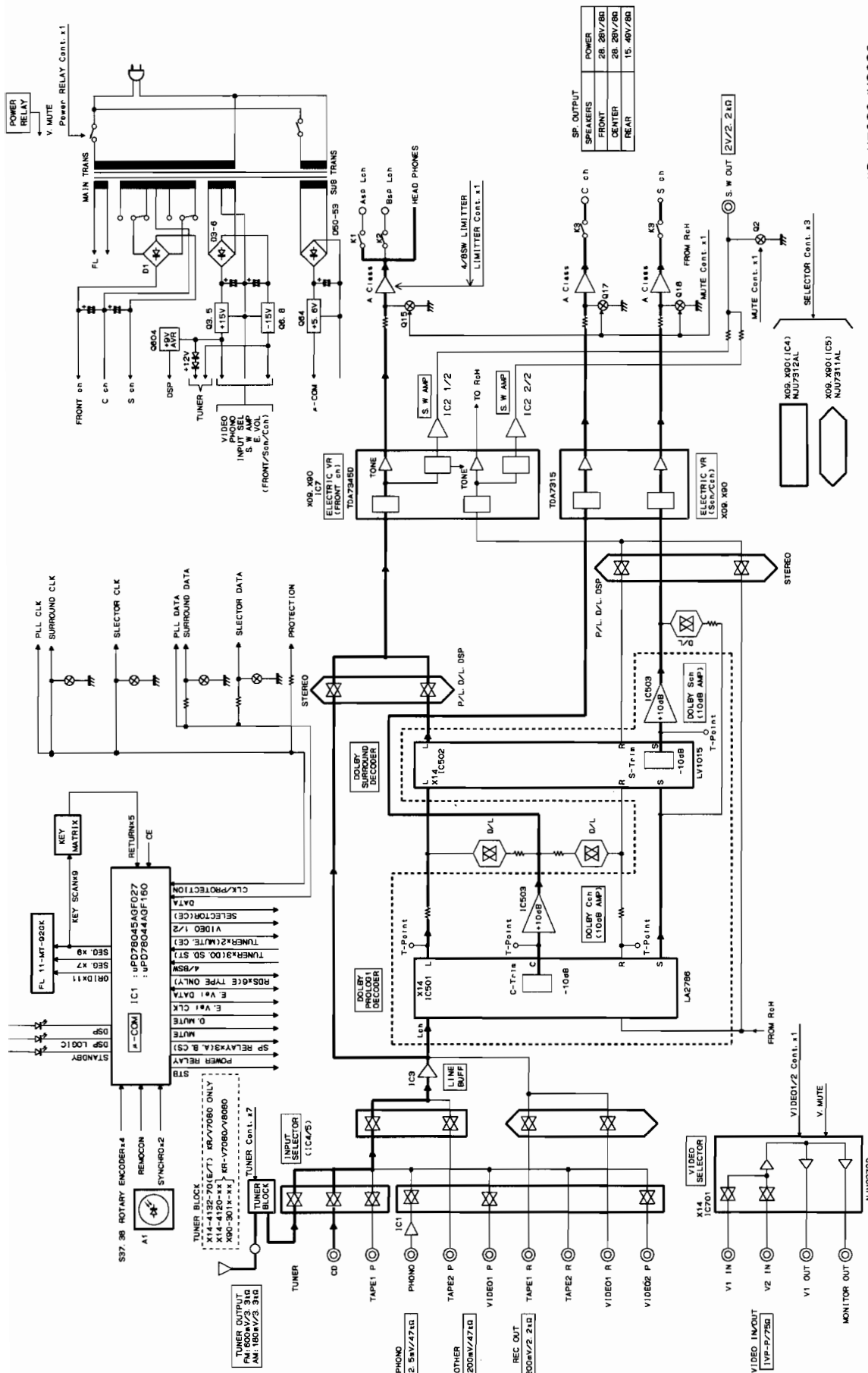

KR-V7080/V8080

KR-V7080/V8080

CIRCUIT DESCRIPTION

1. INITIAL STATE

(1) POWER OFF

(2) AMP-related block

- AUDIO SELECTOR TUNER
- VIDEO SELECTOR VIDEO 1
- SPEAKER A ON
- SPEAKER B OFF
- TAPE 2 MONITOR OFF
- LINE STRAIGHT OFF
- AUDIO ADJUST MODE BALANCE
- BASS 0 dB
- TREBLE 0 dB
- SUB WOOFER 0 step
- BALANCE CENTER
- VOLUME 7 step
- LOUDNESS OFF

(3) SURROUND-related block

- SURROUND MODE STEREO
(SURROUND OFF)
- SURROUND ADJUST MODE DELAY
- DELAY TIME
 - DSP/DSP LOGIC 30ms
 - DOLBY PRO LOGIC 20ms
- CENTER LEVEL 0 dB
- REAR LEVEL 0 dB
- CENTER MODE NORMAL
- DSP MODE ARENA
- DSP LOGIC MODE LARGE

(4) Tune-related block

- BAND FM
- FREQUENCY Lower-limit value of
FM (87.50 MHz)
- AUTO MODE AUTO
- P.CH DISPLAY - - CH

(5) TEST PRESET FREQUENCY

Channel	BAND	K1 TYPE	BAND	K2 TYPE	BAND	E TYPE
01ch	FM	87.50MHz	FM	87.50MHz	FM	87.50MHz
02ch	FM	98.00MHz	FM	98.00MHz	FM	98.00MHz
03ch	FM	108.00MHz	FM	108.00MHz	FM	108.00MHz
04ch	AM	630kHz	AM	630kHz	AM	630kHz
05ch	AM	1000kHz	AM	1000kHz	AM	999kHz
06ch	AM	1440kHz	AM	1440kHz	AM	1440kHz
07ch	FM	87.50MHz	FM	87.50MHz	FM	87.50MHz
08ch	FM	87.50MHz	FM	87.50MHz	FM	87.50MHz
09ch	FM	87.50MHz	FM	87.50MHz	FM	87.50MHz
10ch	FM	89.10MHz	FM	89.10MHz	FM	89.10MHz
11ch	FM	90.00MHz	FM	90.00MHz	FM	90.00MHz
12ch	FM	97.50MHz	FM	97.50MHz	FM	97.50MHz
13ch	FM	98.50MHz	FM	98.50MHz	FM	98.50MHz
14ch	FM	106.00MHz	FM	106.00MHz	FM	106.00MHz
15ch	AM	530kHz	AM	530kHz	AM	531kHz
16ch	AM	990kHz	AM	990kHz	AM	990kHz
17ch	AM	1700kHz	AM	1610kHz	AM	1602kHz
18ch	FM	87.50 MHz	FM	87.50MHz	FM	87.50MHz
19ch	FM	87.50MHz	FM	87.50MHz	FM	87.50MHz
20ch	FM	87.50MHz	FM	87.50MHz	FM	87.50MHz

The initial setting is performed in a following event :

1. When backup memory data is destroyed when reset is applied to the microprocessor.
2. When the power cord is plugged in to the AC wall outlet while pressing the POWER key.

KR-V7080/V8080

CIRCUIT DESCRIPTION

2. BACKUP

This function holds the current state of the unit even if the AC power of the AV receiver is turned OFF.

(1) Operation outline

The backup state set command signal (CE) of a microcomputer is set low when the AC power is turned OFF. The microcomputer detects the signal and enters the stop state.

The microcomputer is reset when the AC power is turned ON. The data for backup state confirmation is checked by reset processing.

The microcomputer is initialized when the data was destroyed. If it is not destroyed, the microcomputer is started in the backup state.

- The data for backup state confirmation is written in a RAM area.
- The microcomputer is set to the STOP mode so as to save the power consumption.
- A backup state set command signal is detected by a timer interrupt of 1 msec.
- The backup guarantee period is set in a circuit.

(2) Backup state setting

- The data (A596H/5A69H) for backup state confirmation is written in a RAM area.
- Setting the special function port
Set the input/output port of a serial interface to the serial interface operation stop mode. Set the FIP controller to the display OFF mode.
- Setting the microcomputer's internal special function
Set all the interrupt enable flags to the disable state, respectively. Set the microcomputer to the STOP mode and stop the system clock oscillation of the microcomputer.

(3) Contents of backup data to be held

- POWER ON/OFF state
- VOLUME LEVEL data
- BALANCE LEVEL data
- N.B.ON/OFF
- SELECTOR SOURCE
- TUNER ----
- LAST BAND
- RECEIVING STATION FREQUENCY data
- PRESET MEMORY data (1ch~40ch)
- AUTO/MANUAL mode

---- AMP ----

- POWER STANDBY ON/OFF
- SELECTOR SOURCE
- VIDEO OUT SOURCE
- TAPE2 MONITOR ON/OFF
- SPEAKER A RELAY ON/OFF
- SPEAKER B RELAY ON/OFF
- VOLUME LEVEL VALUE
- AUDIO ADJUST MODE
- BALANCE LEVEL VALUE
- BASS LEVEL
- TREBLE LEVEL
- SUB WOOFER LEVEL
- LINE STRAIGHT ON /OFF
- LOUDNESS ON/OFF

---- SURROUND ----

- SURROUND MODE
- DSP MODE
- DSP LOGIC MODE
- CENTER MODE
- SURROUND ADJUST MODE
- DELAY TIME
- CENTER LEVEL
- REAR LEVEL

3. PROTECTION

The protection state is entered when abnormality is detected during the POWER-ON sequence.

- The power and speaker are turned OFF when the abnormal state is detected during the POWER-ON sequence.
- The STANDBY LED blinks every 500 msec.
- The fluorescent display indicator goes OFF.

KR-V7080/V8080

CIRCUIT DESCRIPTION

4. DESTINATION LIST OF TUNER

Table 4-1 Destination List of Tuner

Destination	BAND	Receive frequency range	channel space	1F	PLL reference frequency	Destination DSW(X14-)		
						DSW2	DSW1	DSW0
						D31	D16	D29
K1	FM	87.5MHz~108.0MHz	100kHz	+10.7MHz	25kHz	0	0	0
	AM	530kHz~1700kHz	10kHz	+450kHz	10kHz			
K2	FM	87.5MHz~108.0MHz	100kHz	+10.7MHz	25kHz	0	0	1
	AM	530kHz~1610kHz	10kHz	+450kHz	10kHz			
E1	FM	87.5MHz~108.0MHz	50kHz	+10.7MHz	25kHz	0	1	1
	AM	531kHz~1602kHz	9kHz	+450kHz	9kHz			
E3 (RDS)	FM	87.5MHz~108.0MHz	50kHz	+10.7MHz	25kHz	1	0	1
	AM	531kHz~1602kHz	9kHz	+450kHz	9kHz			
M	KZ/E1 changes by only setting "DSW1". (DSW 1=0 : K2 Type, 1 : E1 Type)					0	X	1

DIODE SW(DSWX) : 0 = Without DIODE (When static, input LOW)

1 = With DIODE(When static, input HIGH)

X = TRANSISTOR SW (0 = OFF 1=ON)

※ ATTENTION

A SUB WOOFER output signal is output irrespective of SP selector switch (ASP and BSP) ON/OFF setting

The RDS PTY AF search always corresponds to a span search of 100kHz. Therefore, a span search of 50 kHz cannot be performed.

5. TEST MODE

5-1. TEST MODE OF MAIN UNIT

(1) Setting the test mode

The main unit is put into the test mode when the AC power is turned ON while pressing the "TUNING DOWN" key. The following state is obtained when the test mode of the main unit set.

- The power is turned ON automatically.
- All the fluorescent display indicators and LEDs light.
(The all-illuminated state is cleared by pressing any main unit key.)
- The backup state except when the power is turned ON and OFF is initialized.

(2) Canceling the test mode

Turn OFF the AC power.

(3) Tuner functions

- Preset channel call function
 - 1) Calls channels 1 to 9 (keys 1 to 9) and channel 10 (key 0) when the 10 key is not operated.
 - 2) Calls channels 11 to 19 (keys 1 to 9) and channel 20 (key 0) when the +10 key is operated once.
 - 3) Calls channels 21 to 29 (keys 1 to 9) and channel 30 (key 0) when the +10 key is operated two times and calls channels 31 to 39 (keys 1 to 9) and channel 40 (key 0) when the +10 key is operated three times.

4) Shifts to the operation obtained when the +10 key is not operated if it is operated four times.

- S level hexadecimal data display function
With the selector on TUNER, when the "DOLBY PRO LOGIC" key on the main unit is operated, the frequency display ceases and the S level is displayed in hexadecimal while the key is pressed.
When "3 STEREO" is operated, the display is switched to restore the normal display.
- Mute signal output
No Selector MUTE(MUTE 1) control regulation is done whatever.
- With the selector on TUNER, when the "SP A" key on the main unit is operated, the SP A display is erased and ATT is on. If the "SP A" on the main unit is operated again after that, SP A is displayed and ATT is switched OFF. The SP A operation and ATT operation work together and are combined with switching the ATT display ON and OFF.

※ Under the ATT ON/OFF relationship, ATT can not be entered in an AF search in test mode.

The ATT operation is done from ATT OFF.

If SP A was turned OFF with the selector on something other than TUNER, it will come on when TUNER is selected.

KR-V7080/V8080

CIRCUIT DESCRIPTION

(4) AMP function

The original function of each key is executed when the SELECTOR mode is set to TUNER. The test mode operation is not performed in this case.

- One touch max, mid, min setting for Audio Level and Surround Level

The variation of Audio Level and Surround Level can be operated by turning the Multi-Level UP or DOWN and, if the selector is on something other than TUNER, max, mid, min settings can be made with the number keys.

- 1) Max is number key "2"
- 2) Mid is number key "3"
- 3) Min is number key "1"
- 4) The Mid setting is as follows:

Master VOL. DELAY is the initial value

Balance is centered

BASS, TREBLE, SUB-WOOFER, CENTER and REAR are 0 dB or 0 step

Effect is 1 step

(5) EFFECT is 0 step for Min and 2 step for Max.

- One touch settings for Audio Level and Surround Level items

The variation of Audio Level and Surround Level items can be set with respective keys and, if the selector is on something other than TUNER, direct settings can be made with the number keys.

- 1) Balance is number key "4"
- 2) Bass is number key "5"
- 3) Treble is number key "6"
- 4) Sub-Woofer is number key "7"
- 5) Rear Level is number key "8"
- 6) Center Level is number key "9"
- 7) Delay Time is number key "0"
- 8) Effect Level is number key "+10"

- TEST TONE operation

Uses the "DIRECT" key instead of the "TEST TONE" key.

- MUTE signal output

Sets the analog muting to OFF at all times. No control is performed in this case. Sets the analog muting to ON in the same way as during normal operation when the front volume is set to the minimum value(-∞ dB).

- Impedance 4/8 selection

No impedance 4/8 display appears in the normal state. Therefore, the SPEAKERS lamp of the fluorescent display indicator is turned ON and OFF in the test mode.

The SPEAKERS lamp is turned ON when the impedance is 4.

The SPEAKERS lamp is turned OFF when the impedance is 8.

- MUTE Operation

Mute operation is toggled ON and OFF by pressing the "AUTO/MANUAL" key.

5-2. SERIAL TEST MODE

(1) Setting the serial test mode

The unit is put into the serial test mode when a serial code "TEST ON" is input during the POWER-ON sequence.

In the 8-bit serial test mode, serial code 71H is input.

In the 16-bit serial test mode, serial code C27FH is input.

- In the serial test mode, all remote control keys and ordinary serial codes are disabled. Only the panel keys perform the same operation as usually.

(2) Canceling the serial test mode

- The serial test mode is canceled to return to the ordinary mode by inputting a "TEST OFF" code. After the ordinary mode was returned, the serial mode is returned to the state before the test mode is entered. The backup operation is not initialized.
- The serial test mode is also canceled when the AC power is turned OFF.

(3) Cautions

- The serial test code is prescribed as a 16-bit code only.
- The operations below are inhibited in the serial test mode.
 - Manual tuning UP/DOWN operation
 - UP/DOWN selection in PTY selection mode
 - AF search in ATT ON stateThe operations mentioned above cannot be guaranteed when they are performed in the serial test mode.
- An identical code is output when the serial test mode code is input.
- A TUNED ON/TUNED OFF code is only output.

(4) The serial test mode codes for ATT ON/OFF operate in the same way as for test mode with the main unit keys.

(SP A also goes ON/OFF as ATT goes on/off.)

- Under the ATT ON/OFF relationship, ATT can not be entered in an AF search in test mode. The ATT operation is done from ATT OFF. If SP A was turned OFF with the selector on something other than TUNER, it will come on when TUNER is selected.

KR-V7080/V8080

CIRCUIT DESCRIPTION

(5) SERIAL TEST CODE LIST (C2XXH)

TYPE FUNC	AMP							TUNER								
	0	1	2	3	4	5	6	7	8	9	A	B	C	D	E	F
0	POWER OFF	CD DIRECT OFF	SP B OFF	DUAL SOUND LEVEL1	NB OFF					POWER OFF	0	MEMORY (ENTER)				
1	POWER ON	CD DIRECT ON	SP B ON	DUAL SOUND LEVEL2	OMNI SP ON	FRONT SP ON				POWER ON	1	MAIN				
2	PHONO	CD REC OFF	HIT MASTER OFF	DUAL SOUND LEVEL3	MUTING (-30dB) OFF	FRONT SP OFF				MUTE OFF	2	SUB				
3	CD	CD REC ON	HIT MASTER ON	DUAL SOUND INPUT CD	MUTING (-30dB) ON	C/S SP ON				MUTE ON	3	BOTH				
4	TUNER	SOURCE DIRECT OFF	MOTOR VOL UP	DUAL SOUND INPUT TUNER	NB LEVEL1	C/S SP OFF				AUTO STEREO	4	AF				
5	TAPE (TAPE A)	SOURCE DIRECT ON	MOTOR VOL DOWN	DUAL SOUND INPUT TAPE	NB LEVEL2	C/S MUTE ON				MONO	5	PTY				
6	TAPE2 (TAPE B)	LINE STRAIGHT OFF	MOTOR VOL STOP	DUAL SOUND INPUT MD/DAT	NB LEVEL3	VIDEO5				TUNED OFF	6	DISPLAY				
7	AUX	SINE STRAIGHT ON	DBS/TV	DUAL SOUND INPUT VIDEO	BALANCE L/RH MAX	MENU				TUNED ON	7					
8	DAT	LOUDNESS OFF	TAPE2 MONITOR OFF	DUAL SOUND INPUT AV/AUX	BALANCE L/RH CENTER	tone CONTROL OFF				ACTIVE RECEPTION OFF	8					
9	VIDEO1 (VIDEO)	LOUDNESS ON	TAPE2 MONITOR ON	BGM OFF	BALANCE L/RH MAX	tone CONTROL ON		FL ALL OFF OFF		ACTIVE RECEPTION ON	9					FL ALL OFF OFF
A	VIDEO2	SUB SONIC OFF	VIDEO MUTE ON	BGM ON	L.A.C. MAIN MAX	BASS MIN		FL ALL OFF ON		RF DIRECT	+10					FL ALL OFF ON
B	VIDEO3	SUB SONIC ON	LAC VOL UP	FAN OFF	L.A.C. MAIN/SUB CENTER	BASS MID		ALL ON OFF		ATT ON	BAND FM					ALL ON OFF
C	VIDEO4 (VDP)	SUPER WOOFER OFF	LAC VOL DOWN	FAN ON	L.A.C. SUB MIN	BASS MIX		ALL ON ON		ATT OFF	BAND AM/FM					ALL ON ON
D	MUTE ON (MAIN)	SUPER WOOFER ON	LAC VOL STOP	FAN SPEED LOW	FAN STOP LOW	TREBLE MIN		AMP INITIAL		IF NORMAL	BAND TVLW					TUNER SERIAL TEST OFF
E	SEL MUTE ON	SPEAKER A OFF (FRONT)	DUAL SOUND OFF	FAN SPEED HIGH	FAN STOP HIGH	TREBLE MID		AMP SERIAL TEST OFF		IF NARROW	DOWN					TUNER SERIAL TEST OFF
F	MUTE ALL OFF	SPEAKER A ON (FRONT)	DUAL SOUND ON	NB ON		TREBLE MAX		AMP SERIAL TEST ON		DIRECT	UP					TUNER SERIAL TEST ON

□ : Sending code ■ : Receiving code

(C3XXH)

TYPE FUNC	SURROUND							GE								
	0	1	2	3	4	5	6	7	8	9	A	B	C	D	E	F
0	POWER OFF	REAR MUTE ON	ASFC MAX	ACOUSTIC BGM	PRESENCE GAME	ECHO 2	SUB WOOFER LEVEL MIN		POWER OFF	EQ JAZZ						
1	POWER ON	MUTE ALL OFF	SEAT POS MIN	CINEMA SCREEN OFF	PRESENCE KARAOKE	PRESENCE HIT MASTER	SUB WOOFER LEVEL MID		POWER ON	EQ FUSION						
2	STEREO BYPASS/OFF	CENTER LEVEL MIN	SEAT POS MID	CINEMA SCREEN 1	F 2ch	THX	SUB WOOFER LEVEL MAX		MUTE OFF	EQ MOVIE						
3	DOLBY SURROUND NORMAL/WID	CENTER LEVEL MID	SEAT POS MAX	CINEMA SCREEN 2	DOLBY SURROUND (PHANTOM)	MONO			MUTE ON							
4	DOLBY 3 STEREO	CENTER LEVEL MAX	WALL MIN	CINEMA SCREEN 3	DEPTH OFF	INPUT LEVEL MIN			EQ OFF							
5	DSP	REAR R LEVEL MIN	WALL MID	CH MODE 2ch	DEPTH ON	INPUT LEVEL MID			EQ ON							
6	DSP LOGIC	REAR R LEVEL MID	WALL MAX	CH MODE 3ch	DEPTH MODE VOCAL	INPUT LEVEL MAX			M1 (ALL CEN)							
7	S 4ch	REAR R LEVEL MAX	ROOM SIZE MIN	CH MODE 4ch	DEPTH MODE INSTRUMENT	FRONT L LEVEL MIN			M2 (ALL MAX)							
8	F 4ch	DELAY TIME MIN	ROOM SIZE MID	CH MODE 5ch	DEPTH LEVEL MIN	FRONT L LEVEL MID			M3 (ALL MIN)							
9	CENTER MODE NORMAL	DELAY TIME MID	ROOM SIZE MAX	DSP THROUGH	DEPTH LEVEL MID	FRONT L LEVEL MAX		FL ALL OFF OFF	EEPROM TEST							FL ALL OFF OFF
A	CENTER MODE WIDE	DELAY TIME MAX	STEREO (KARAOKE)	DSP ARENA	DEPTH LEVEL MAX	FRONT R LEVEL MIN		FL ALL OFF ON	EEPROM TEST OK							FL ALL OFF ON
B	CENTER MODE PHANTOM	(PRESENCE) EFFECT LEVEL MIN	MULTI (KARAOKE)	DSP JAZZ CLUB	SUB(OMNI) MUTE ON	FRONT R LEVEL MID		ALL ON OFF	EEPROM TEST NG							ALL ON OFF
C	TEST TONE OFF	(PRESENCE) EFFECT LEVEL MID	HIFI MULTI (KARAOKE)	DSP STADIUM	DSP LOGIC LARGE	FRONT R LEVEL MAX		ALL ON ON	LINE ON							ALL ON ON
D	TEST TONE ON	(PRESENCE) EFFECT LEVEL MAX	NORMAL (KARAOKE)	PRESENCE DISCO THEQUE	DSP LOGIC SMALL	REAR L LEVEL MIN		SURROUND INITIAL	TAPE ON							GE INITIAL
E	FRONT MUTE ON	ASFC MIN	ACOUSTIC NON DIRE1	PRESENCE CHURCH	ECHO OFF	REAR L LEVEL MID		SURROUND SERIAL TEST OFF	EQ POP							GE SERIAL TEST OFF
F	CENTER MUTE ON	ASFC MID	ACOUSTIC NON DIRE2	PRESENCE MOVIE	ECHO 1	REAR L LEVEL MAX		SURROUND SERIAL TEST ON	EQ ROCK							GE SERIAL TEST ON

□ : Sending code ■ : Receiving code

KR-V7080/V8080

CIRCUIT DESCRIPTION

(C4XXH)

H L	VOLUME LEVEL															
	0	1	2	3	4	5	6	7	8	9	A	B	C	D	E	F
0	VOLUME 0	VOLUME 16	VOLUME 32	VOLUME 48	VOLUME 64											
1	VOLUME 1	VOLUME 17	VOLUME 33	VOLUME 49	VOLUME 65											
2	VOLUME 2	VOLUME 18	VOLUME 34	VOLUME 50	VOLUME 66											
3	VOLUME 3	VOLUME 19	VOLUME 35	VOLUME 51	VOLUME 67											
4	VOLUME 4	VOLUME 20	VOLUME 36	VOLUME 52	VOLUME 68											
5	VOLUME 5	VOLUME 21	VOLUME 37	VOLUME 53	VOLUME 69											
6	VOLUME 6	VOLUME 22	VOLUME 38	VOLUME 54	VOLUME 70											
7	VOLUME 7	VOLUME 23	VOLUME 39	VOLUME 55	VOLUME 71											
8	VOLUME 8	VOLUME 24	VOLUME 40	VOLUME 56	VOLUME 72											
9	VOLUME 9	VOLUME 25	VOLUME 41	VOLUME 57	VOLUME 73											
A	VOLUME 10	VOLUME 26	VOLUME 42	VOLUME 58	VOLUME 74											
B	VOLUME 11	VOLUME 27	VOLUME 43	VOLUME 59	VOLUME 75											
C	VOLUME 12	VOLUME 28	VOLUME 44	VOLUME 60	VOLUME 76											
D	VOLUME 13	VOLUME 29	VOLUME 45	VOLUME 61	VOLUME 77											
E	VOLUME 14	VOLUME 30	VOLUME 46	VOLUME 62	VOLUME 78											
F	VOLUME 15	VOLUME 31	VOLUME 47	VOLUME 63												

◻ : Sending code ◼ : Receiving code

KR-V7080/V8080

CIRCUIT DESCRIPTION

6. Microprocessor : μ PD78044AGF160 (X14 : IC1)
 μ PD78045AGF027

Block diagram

μ PD78044AGF160 [K, P, M, X, Y, type]

μ PD78045AGF027 [E, T type]

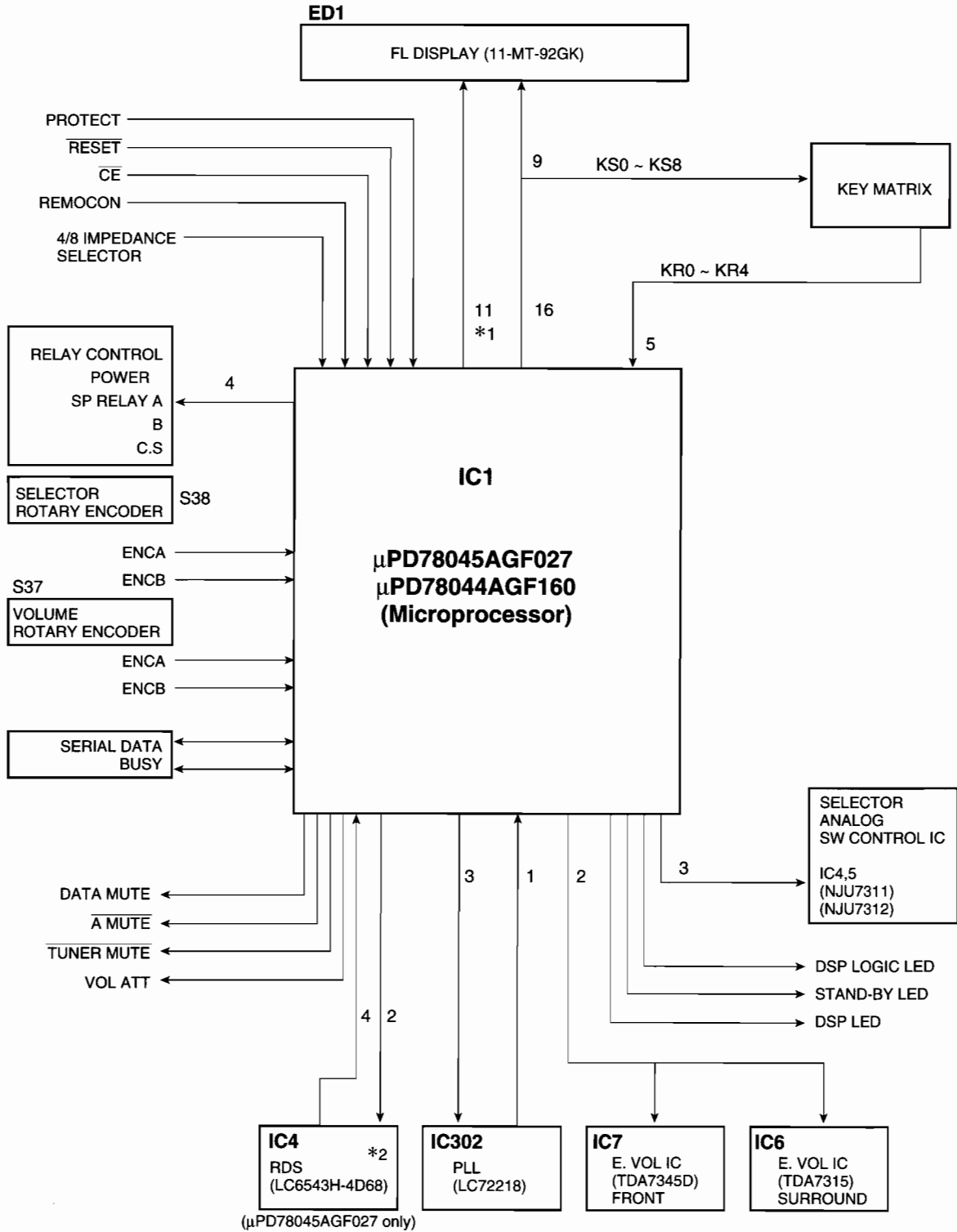

*1 GRID to FL

*2 E3 Type (RDS feature installed) used RDS cynic microprocessor (LC6543H-4D68).

KR-V7080/V8080

CIRCUIT DESCRIPTION

6-1. PIN FUNCTION

Pin NO.	Pin name	Port I/O	Name	Description	Active
1	P94/FIP6	O	5G	FL grid 5	————
2	P93/FIP5	O	6G	FL grid 6	————
3	P92/FIP4	O	7G	FL grid 7	————
4	P91/FIP3	O	8G	FL grid 8	————
5	P90/FIP2	O	9G	FL grid 9	————
6	P81/FIP1	O	10G	FL grid 10	————
7	P80/FIP0	O	11G	FL grid 11	————
8	Vcc	—	VDD	Micro processor power supply	————
9	P27/SCK0	I/O	PROTECT/CLK	IN : Protection detection OUT : Control IC clock	H : ON
10	P26/S00/SBI	—	DATA	OUT : PLL IC/Selector IC/Surround IC control data	————
11	P25/S10/SB0	O	SUR ST.	Surround IC strobe	H : NORMAL L : TRANSFER
12	P24/BUSY	O	SEL ST.	Selector IC strobe	H : NORMAL L : TRANSFER
13	P23/STB	O	POWER RELAY	Power relay control	H : ON
14	P22/SCK1	O	SP B RELAY	Speaker B relay control	H : ON L : OFF
15	P21/S01	O	SP A RELAY	Speaker A relay control	H : ON L : OFF
16	P20/SI1	O	SP CS RELAY	Surround speaker relay control	H : ON L : OFF
17	RESET	I	RESET	Microprocessor reset	L : RESET ON
18	P74	I	4/8 SELECT	IN : Speaker impedance selector	H : 4Ω L : 8Ω
19	P73	I	CE	AC OFF(MAIN POWER) detection Signal	L : AC OFF
20	AVSS	—	AVSS	A/D power SUPPLY (GND)	————
21	P73/P17/AN17	O	A MUTE	Volume IC address/data CE Analog mute signal	L : ON
22	P16/AN16	O	TUNER MUTE	Tuner mute control	L : MUTE ON
23	P15/AN15	I	STEREO	Stereo signal detection	L : STEREO ON
24	P14/AN14	I	SD	Synchronized signal detection	————
25	P13/AN13	I	DO	IF count data (PLL DO)	————
26	P12/AN12	O	CE(PLL)	PLL Chip enable control	————
※27	P11/AN11	O	ATT (RDS)	Attenuate control	H : ON
※28	P10/AN10	I	S.LEVEL (RDS)	Signal level	H : ON
29	A Vcc	—	VDD	A/D power supply	————
30	A Vref	—	+5V	A/D reference voltage	————
31	P04/XT1	I	VOLUME ENCB	Volume encoder input B	————
32	XT2	—	NC		————
33	Vss	—	Vss	Microprocessor power supply	————
34	X1	—	OSC	4.19MHz oscillator	————
35	X2	—	OSC	4.19MHz oscillator	————
36	P37	I	VOLUME ENCA	Volume encoder in put A	————
37	P36/BUZ	O	SDA	Electric volume IC control data	————
38	P35/PCL	O	SCL	Electric volume IC control clock	————
39	P34/T12	I	SELECTOR ENCB	Selector encoder input B	————
40	P33/T11	I	SELECTOR ENCA	Selector encoder input A	————
41	P32/T02	I/O	S.DATA	8/16 bit system data	————
42	P31/T01	I/O	S.BUSY	8/16 bit system busy	H : BUSY L : READY
※43	P30/T00	O	RES (RDS)	RDS IC reset signal	L : RESET ON
※44	P03/INTP3/C10	I	CLK (RDS)	RDS clock	————

※E/T type only, other types unused.

KR-V7080/V8080

CIRCUIT DESCRIPTION

Pin NO.	Pin name	Port I/O	Name	Description	Active
※45	P02/INTP2	I	DATA(RDS)	RDS data	_____
※46	P01/INTP1	I	START(RDS)	RDS data start signal	L : START
47	P00/INTP0/TI	I	REM	Remote control input	_____
48	IC	—	Vss		_____
49	P72	O	STANDBY LED	Standby LED	L : LED ON
50	P71	O	DSP LOGIC LED	DSP LOGIC LED	L : LED ON
51	P70	O	DSP LED	DSP LED	L : LED ON
52	VDD	—	VDD	Microprocessor power supply (+5V)	_____
53	P127/FIP33	O	VOL ATT	Volume(-12.5dB) attenuate signal	H : ATT ON L : ATT OFF
54	P126/FIP32	O	DATA MUTE	Data mute control	H : ON
55	P125/FIP31	I	KR4	Key return 4	_____
56	P124/FIP30	I	KR3	Key return 3	_____
57	P123/FIP29	I	KR2	Key return 2	_____
58	P122/FIP28	I	KR1	Key return 1	_____
59	P121/FIP27	I	KR0	Key return 0	_____
60	P120/FIP26	O	P16KS8	FL Segment 16/key scan 8	_____
61	P117/FIP25	O	P15/KS7	FL Segment 15/key scan 7	_____
62	P116/FIP24	O	P14/KS6	FL Segment 14/key scan 6	_____
63	P115/FIP23	O	P13/KS5	FL Segment 13/key scan 5	_____
64	P114/FIP22	O	P12/KS4	FL Segment 12/key scan 4	_____
65	P113/FIP21	O	P11/KS3	FL Segment 11/key scan 3	_____
66	P112/FIP20	O	P10/KS2	FL Segment 10/key scan 2	_____
67	P111/FIP19	O	P9/KS1	FL Segment 09/key scan 1	_____
68	P110/FIP18	O	P8/KS0	FL Segment 08/key scan 0	_____
69	P107/FIP17	O	P1	FL Segment 1	_____
70	P106/FIP16	O	P2	FL Segment 2	_____
71	V load	—	V load	FL drive power supply (-30V)	_____
72	P105/FIP15	O	P3	FL Segment 3	_____
73	P104/FIP14	O	P4	FL Segment 4	_____
74	P103/FIP13	O	P5	FL Segment 5	_____
75	P102/FIP12	O	P6	FL Segment 6	_____
76	P101/FIP11	O	P7	FL Segment 7	_____
77	P100/FIP10	O	G1	FL grid 1	_____
78	P97/FIP9	O	G2	FL grid 2	_____
79	P96/FIP8	O	G3	FL grid 3	_____
80	P95/FIP7	O	G4	FL grid 4	_____

※The RDS PTY AF search always corresponds to a span search of 100kHz. Therefore, a span search of 50 kHz cannot be performed.

KR-V7080/V8080

CIRCUIT DESCRIPTION

7. KEY MATRIX

[() : μ -com IC port]

Table 7-1 Key Matrix List

KRTN KSCN	KR0 (59)	KR1 (58)	KR2 (57)	KR3 (56)	KR4 (55)
KS0 (68)	—	*1 RDS PTY	*1 RDS AF	*1 RDS DISPLAY	—
KS1 (67)	6 (10KEY)	5 (10KEY)	—	LOUDNESS	TAPE 2
KS2 (66)	7 (10KEY)	4 (10KEY)	—	MEMORY	LINE STRAIGHT
KS3 (65)	8 (10KEY)	3 (10KEY)	+10	DIRECT	AUDIO LEVEL MODE
KS4 (64)	9 (10KEY)	2 (10KEY)	REMOTE POWER	AUTO	SURROUND LEVEL MODE
KS5 (63)	0 (10KEY)	1 (10KEY)	SPEAKER A	SPEAKER B	MULTI DOWN
KS6 (62)	PRO LOGIC	DSP LOGIC	STEREO	TUNING DOWN	MULTI UP
KS7 (61)	3 STEREO	DSP	BAND	TUNING UP	CENTER MODE
KS8 (60)	* 3 DSW0	* 3 DSW1	* 3 DSW2	* 2 DSW3	—

* 1 The destination is E3 type only. For another destination, there is no key. (RDS function)

* 2 Used for operation selector of 8- or 16- bit serial data.

* 3 Used for discrimination of the destination. (Refer to the Destination List of Tuner in Table 5-1.)

8. XS8/XL16 Function

Implements an additional operation by the system in order to shift a system operated by XS8 to SL16.

8-1. Addition of a selector source

Adding a system operation adds selector sources MD and LD and controls MD and LD system operation.

(1) Selector source switching

MD and LD are switched as TAPE1 and VIDEO2 background modes separately from the normal selector functions.

- Switch the selector source by holding down the AUTO panel key for at least two seconds.

TAPE1 -> MD

VIDEO2 -> LD

(If another key is entered while the key is being entered, the key input is set to off and the key is made ineffective.)

When a MD or LD is used, the MD is connected to the RCA Pin of TAPE1 and the LD to the RCA Pin/Video Input of VIDEO2.

- The operation of the system controls only the currently selected source and has no control whatsoever over the operation of the side which is not selected.

For example, while MD is selected, even if the "Deck B Play" serial code is received, MD will remain selected without switching from MD to TAPE1.

(2) Settings during microprocessor backup or initialization

- During microprocessor initialization the selector is set to TAPE1 and VIDEO2. The current selector mode (TAPE1/MD and VIDEO2/LD) is maintained except when the backup is disrupted.

(3) Other items be noted

- This selector switching function has been developed in accordance with new serial codes. Therefore, if XS8 is used, since there is no code for MD and LD, the selector

source function will not work if the 8/16-bit serial mode is 8-bit. It works only in 16-bit mode.

Also, if serial mode has been switched from 16-bit to 8-bit when MD and LD are being selected, it will force a switch to TAPE1 and VIDEO2.

8-2. Changeover preference order

- Pressing KEY, then turn on power.



- Backup data of ①.



- Diode matrix changeover.

8-3. XS8 / SL16 Selection

- KS8 and KR3 are used for the operation selection of 8- or 16- bit serial data. The 8- and 16- bit serial data are selected only during reset initialization.

Table 8-1 8-/16- bit Selection

Serial cord	DSW	DSW3
8- bit serial		0
16- bit serial		1

9. System operation of SL16

Easy operation one way amplifier and receiver. Other source devices are compatible with one-way and two-way easy operation. Operation is 16-bit.

Operation is two way and compatible with operating mode display. Also, adding MD and LD to input selector makes it compatible with easy operation. Apart from TUNER, source devices are operating mode display compatible and input selector MD and LD compatible. Since it is not possible for the amplifier and receiver to be always compatible with operating mode displays, they are only input selector MD and LD compatible and SL16 compatible.

KR-V7080/V8080

ADJUSTMENT

FM SECTION SELECTION : FM
KR-V7080 (E,T TYPE)

NO.	ITEM	INPUT SETTINGS	OUTPUT SETTINGS	TUNER SETTINGS	ALIGNMENT POINTS	ALIGN FOR	FIG.
1	DISCRIMINATOR	(A) 98.0kHz 1kHz, ± 40 kHz dev. (E,T type) 60 dB μ (ANT input)	Connect a DC voltmeter between TP3 and TP4 (X14-) (B/6)	MONO 98.0MHz	L 303 (X14-) (B/6)	0V	(a)
2	DISTORTION (STEREO)	(C) 98.0MHz 1kHz, ± 40 kHz dev. Pilot: ± 6 kHz dev. 60dB μ (ANT input)	(B)	AUTO 98.0MHz	A301 (X14-) (B/6)	Minimum distortion.	(a)

KR-V7080 (OTHER TYPE) / KR-V8080

NO.	ITEM	INPUT SETTINGS	OUTPUT SETTINGS	TUNER SETTINGS	ALIGNMENT POINTS	ALIGN FOR	FIG.
1	DISTORTION (STEREO)	(C) 98.0MHz 1kHz, ± 67.5 kHz dev. Pilot: ± 7.5 kHz dev. 60dB μ (ANT input)	(B)	AUTO 98.0MHz	A301 (X14-) (B/6)	Minimum distortion.	(a)

AUDIO SECTION

NO.	ITEM	INPUT SETTINGS	OUTPUT SETTINGS	TUNER SETTINGS	ALIGNMENT POINTS	ALIGN FOR	FIG.
POWER: ON SPEAKER: B SELECTOR: PHONO							
1	IDLE CURRENT		(E) Connect a DC voltmeter across CP1(L) CP2(R) CP3(CENTER) CP4(REAR) (X09-) (A/4)	Volume: 0	VR1(L) VR2(R) VR3(CENTER) VR4(REAR) (X09-) (A/4)	20mV	(b)

(a)

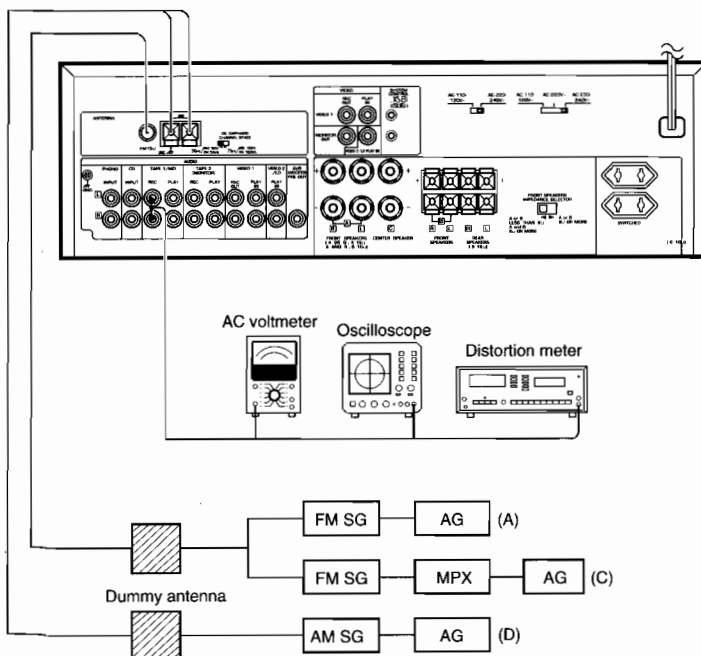

(b)

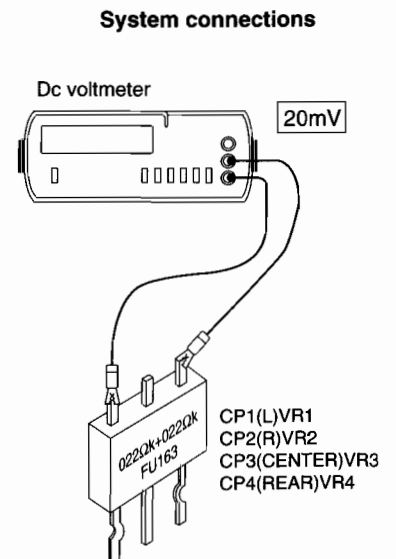

KR-V7080/V8080

WIRING DIAGRAM

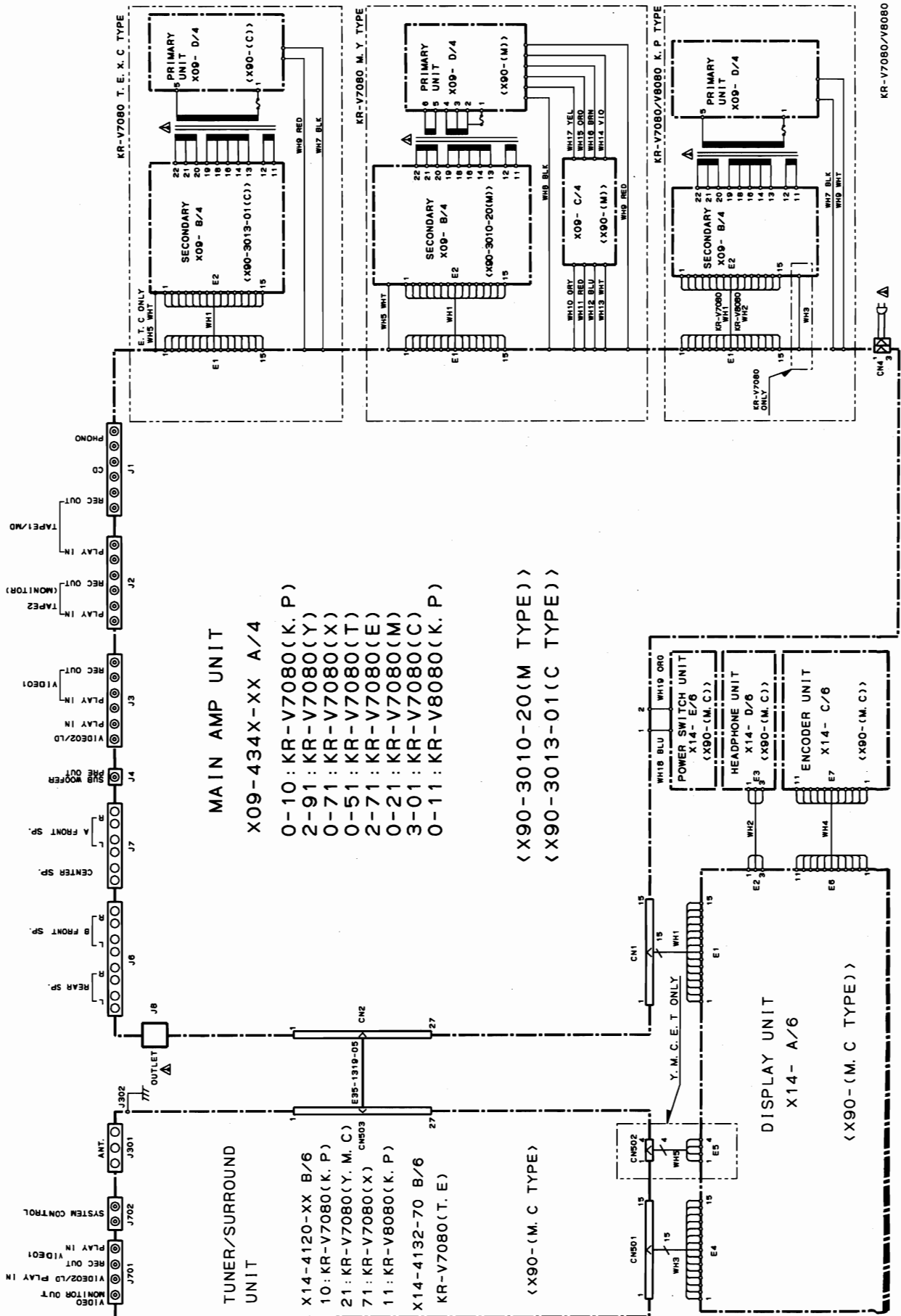

PC BOARD (Component side view)

DISPLAY unit (X14-41xx-xx) 20-10 : KR-V7080 K,P 20-21 : KR-V7080 Y,M,C 20-71 : KR-V7080 X
 32-70 : KR-V7080 T,E 20-11 : KR-V8080 K,P

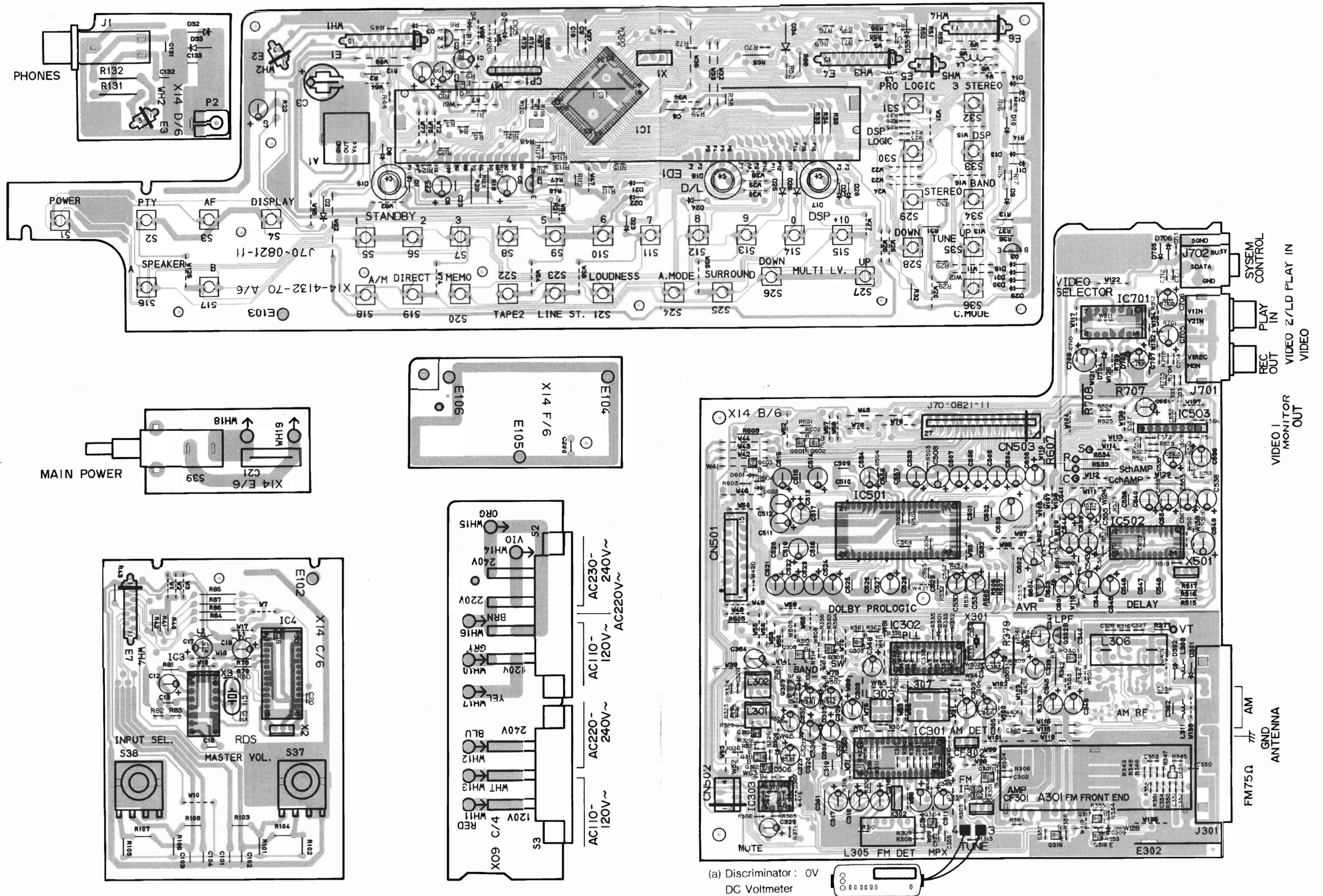

(a) Discriminator : 0V
 DC Voltmeter

Refer to the schematic diagram for the values of resistors and capacitors.

PC BOARD (Component side view)

AUDIO unit (X09-434x-xx)

0-10 : KR-V7080 K,P
2-71 : KR-V7080 E

0-21 : KR-V7080 M
2-91 : KR-V7080 Y

0-51 : KR-V7080 T
3-01 : KR-V7080 C

0-71 : KR-V7080 X
0-11 : KR-V8080 K,P

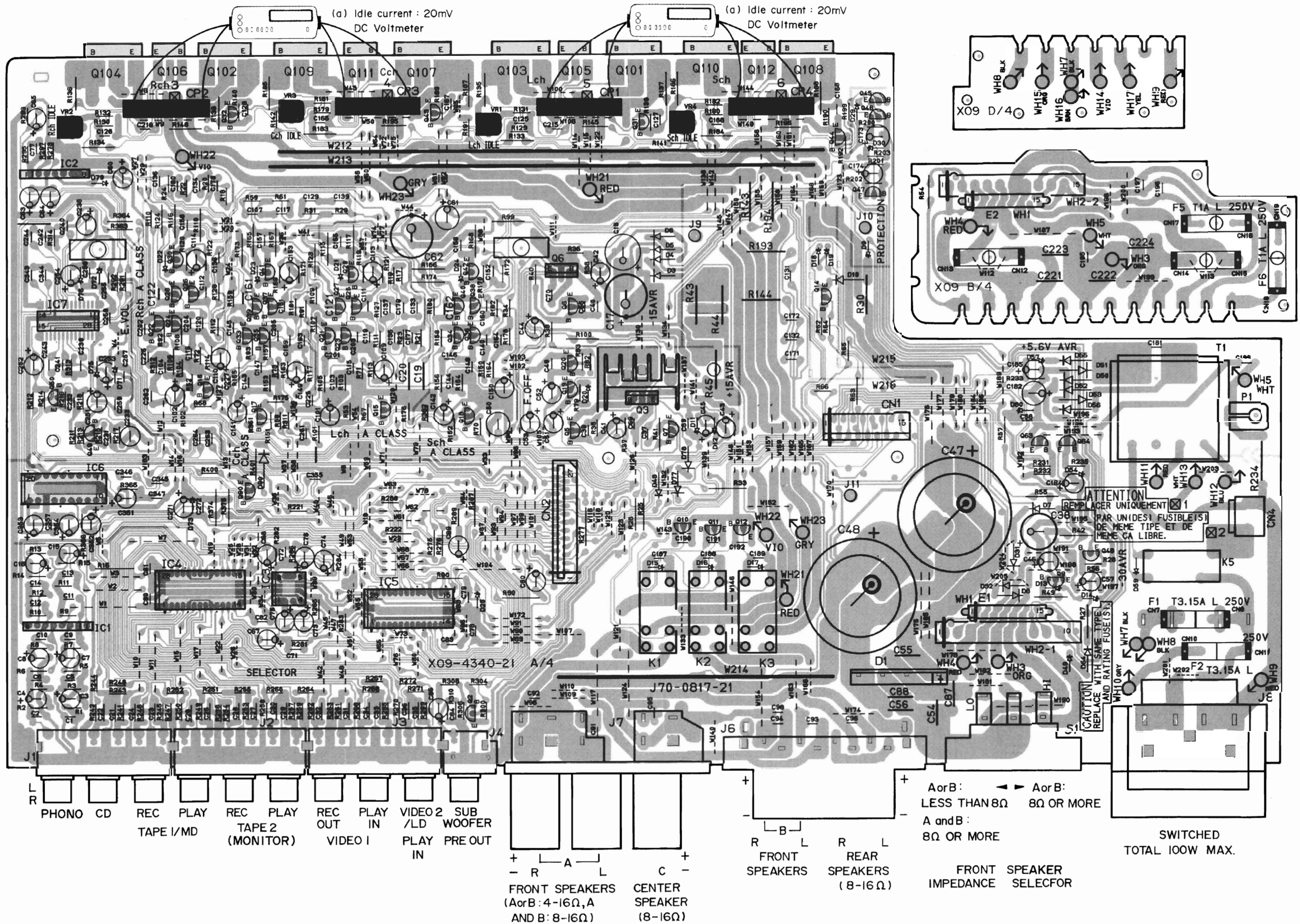

1
2
3
4
5
6
7

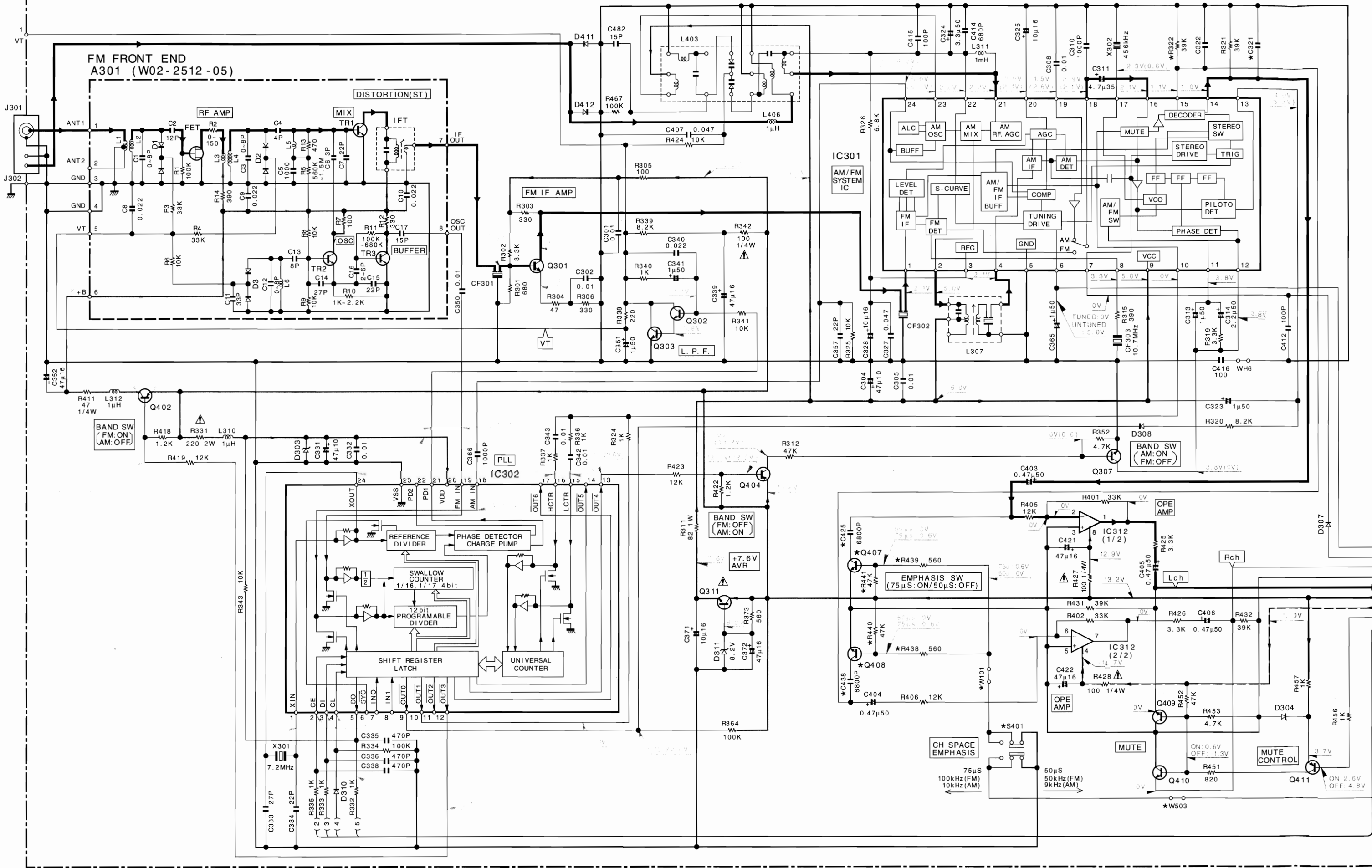

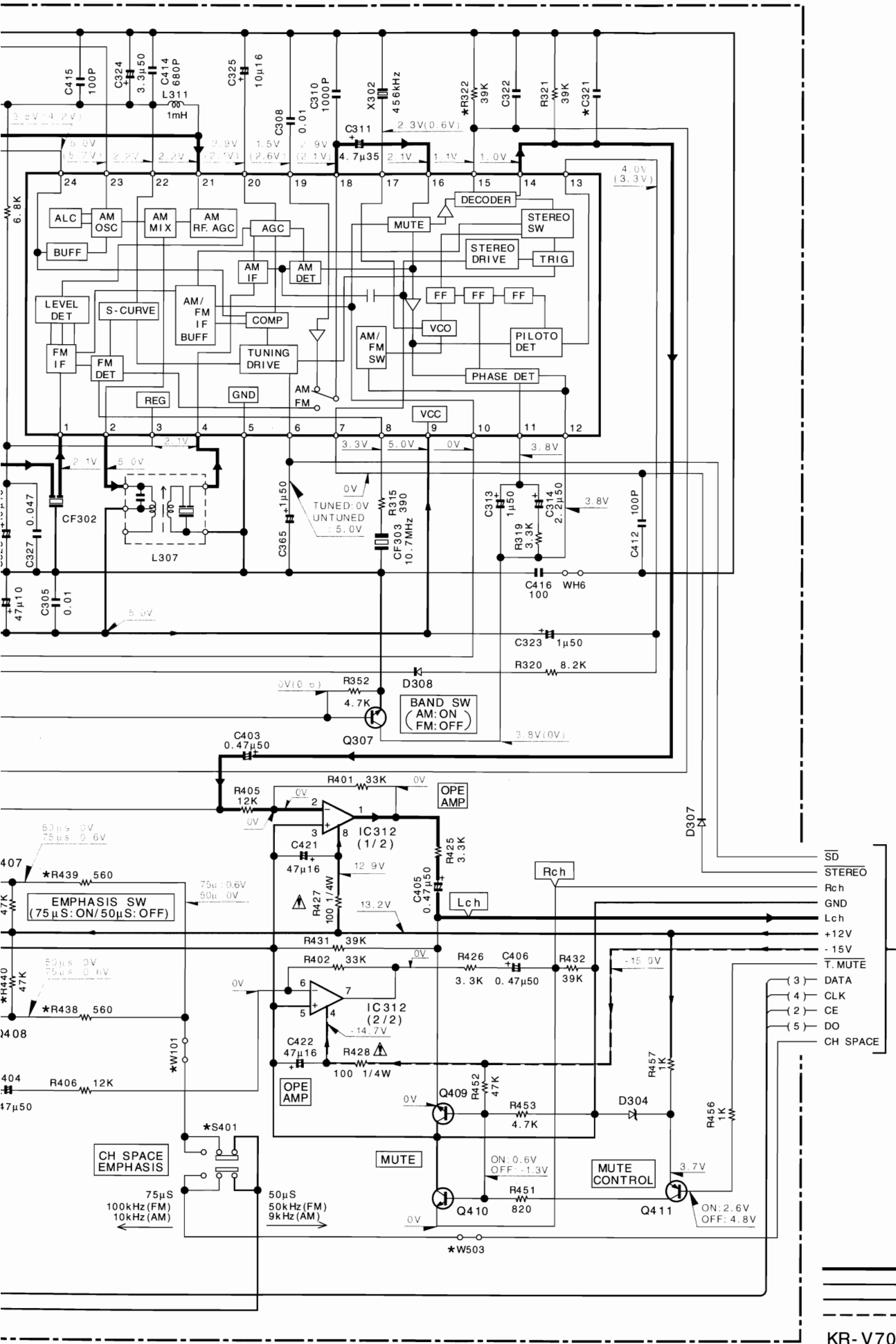

TO X14
TO X90
(A) 3/5
KR-V7080/V8080

- IC301 : LA1831A-KEN
- IC302 : LC7218
- IC312 : NJM4565D
- Q301 : 2SC2714(R, O)
- Q302 : 2SC1845(F, E)
- Q303 : 2SC2458(Y, GR) or 2SC3311A(Q, R)
- Q307, 407, 408 : 2SC4081(R, S) or 2SC4116(Y, GR)
- Q311 : 2SC3940A(R, S) or 2SD863(E, F)
- Q402, 404, 411 : 2SA1576A(R, S) or 2SA1586(Y, GR)
- Q409, 410 : 2SD1757K
- D303 : RD5.1ES(B2) or HZS5.1N(B2)
- D304 : RD3.3ES(B2) or HZS3.3N(B2)
- D307, 308 : 1SS133 or HSS104
- D310, 411, 412 : MA111
- D311 : RD8.2ES(B2) or HZS8.2N(B2)

MODEL NAME	DESTINATION		UNIT NO.	C321, C322	R438-R441, C425, C438, Q407, Q408, S401, W101, W503
	COUNTRY	ABB.			
KR-V7080	U. S. A.	K	20-10	0.024	NO
	CANADA	P	20-10	0.024	NO
	AUSTRALIA	X	20-71	0.016	YES
KR-V8080	GENERAL MARKET	M	20-21	0.016	YES
	CHINA	C	20-21	0.016	YES
KR-V8080	U. S. A.	K	20-11	0.024	NO
	CANADA	P	20-11	0.024	NO

— SIGNAL LINE
— GND LINE
— +B LINE
- - -B LINE

KR-V7080/V8080 (1/5)

CAUTION: For continued safety, replace safety critical components only with manufacturer's recommended parts (refer to parts list). ⚠ indicates safety critical components. For continued protection against risk of fire, replace only with same type and rating fuse(s). To reduce the risk of electric shock, leakage-current or resistance measurements shall be carried out (exposed parts are acceptably insulated from the supply circuit) before the appliance is returned to the customer.

The DC voltage is an actual reading measured with a high impedance type voltmeter as the AM/FM signal generator is specified to the conditions as shown in the list below. The measurement value may vary depending on the measuring instruments used or on the product. The value shown in () is actual reading measured in the AM mode.

MODE	CARRIER	MODULATION		ANT INPUT
		FREQUENCY	DEVIATION	
FM	98MHz	1kHz	STEREO 67.5kHz 7.5kHz(Pilot)	60dB
AM	1000(999)kHz	400Hz	MONO 30% MOD	60dB

- 2SA1123
- 2SA1534A
- 2SA992
- 2SC1845
- 2SC2003
- 2SC2631
- 2SC2878
- 2SC3940A
- 2SD863
- DTC124ES
- 2SA1048
- 2SC2458
- DTC124EU
- 2SA1586
- 2SC2714
- 2SC4081
- 2SC4116
- 2SD1757K

- 2SB1370
- 2SD2061
- UN4212
- UN4219
- 2SA1309A
- 2SC3311A
- 2SB1375
- 2SD2012
- 2SB1559
- 2SD2389

- TDA7315
- SAA6579
- M5223P
- NJM4580D-D
- NJM4580L-D

- LA2786
- NJM4565L-D
- LC7218
- LV1015
- NJU7311
- NJU7312

TO X14
TO X90



KR-V7080/V8080

CAUTION: For continued safety, replace safety critical components only with manufacturer's recommended parts (refer to parts list). Δ indicates safety critical components. For continued protection against risk of fire, replace only with same type and rating fuse(s). To reduce the risk of electric shock, leakage-current or resistance measurements shall be carried out (exposed parts are acceptably insulated from the supply circuit) before the appliance is returned to the customer.

The DC voltage is an actual reading measured with a high impedance type voltmeter as the AM/FM signal generator is specified to the conditions as shown in the list below. The measurement value may vary depending on the measuring instruments used or on the product. The value shown in () is actual reading measured in the AM mode.

MODE	CARRIER	MODULATION		ANT INPUT
		FREQUENCY	DEVIATION	
FM	98MHz	1kHz	STEREO 67.5kHz 7.5kHz(Pilot)	60dB
AM	1000(999)kHz	400Hz	MONO 30% MOD	60dB

2SA1123
2SA1534A
2SA992
2SC1845
2SC2003
2SC2631

2SC2878
2SC3940A
2SD863

DTC124ES
2SA1048
2SC2458

DTC124EU
2SA1586
2SC2714
2SC4081
2SC4116
2SD1757K

2SB1470 *5
2SC4137F50
2SD2222 *5

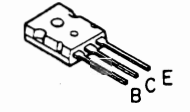
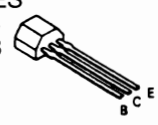
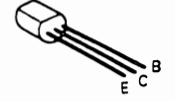

IC301 : LA1831A-KEN
IC302 : LC7218
IC312 : NJM4565D

Q301 : 2SC 2714 (R, O)
Q302 : 2SC 1845 (F, E)
Q303 : 2SC 2458 (Y, GR) or
2SC 3311A (Q, R)

Q307, 407, 408 : 2SC4081 (R, S) or
2SC 4116 (Y, GR)

Q311 : 2SC3940A (R, S) or
2SD863 (E, F)

Q402, 404, 411 : 2SA 1576A (R, S) or
2SA 1586 (Y, GR)

Q409, 410 : 2SD 1757K

D303 : RD5. 1ES (B2) or
HZS5. 1N (B2)

D304 : RD3. 3ES (B2) or
HZS3. 3N (B2)

D307, 308 : 1SS133 or
HSS104

D310, 411, 412 : MA111
D311 : RD8. 2ES (B2) or
HZS8. 2N (B2)

2SB1370
2SD2061

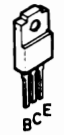

UN4212
UN4219
2SA1309A
2SC3311A

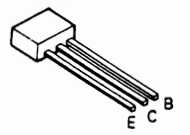

2SB1375
2SD2012



2SB1559
2SD2389



NJM4565D

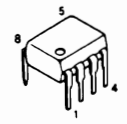

NJM2279D

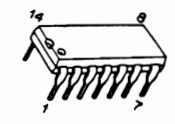

TDA7315

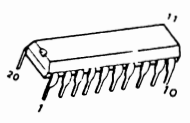

SAA6579

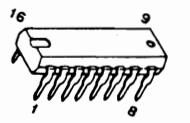

M5223P
NJM4580D-D
NJM4580L-D



UN5212



LA1836

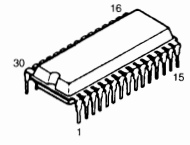

UPD78044AGF160
UPD78045AGF027

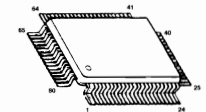

LA2786

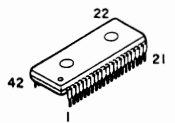

NJM4565L-D

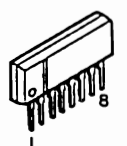

LC7218
LV1015

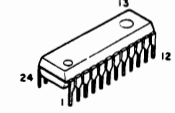

NJU7311AL
NJU7312AL

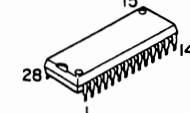

MODEL NAME	DESTINATION		UNIT NO.	C321, C322,	R438-R441, C425, C438, Q407, Q408, S401, W101, W503
	COUNTRY	ABB.			
KR-V7080	U. S. A.	K	20-10	0.024	NO
	CANADA	P			
	AUSTRALIA	X	20-71	0.016	YES
GENERAL MARKET CHINA	M C				
KR-V8080	U. S. A.	K	20-11	0.024	NO
	CANADA	P			

— SIGNAL LINE
— GND LINE
— +B LINE
— -B LINE

X14-4132-70 (E.T TYPE) (TUNER UNIT) KR-V7080 ONLY

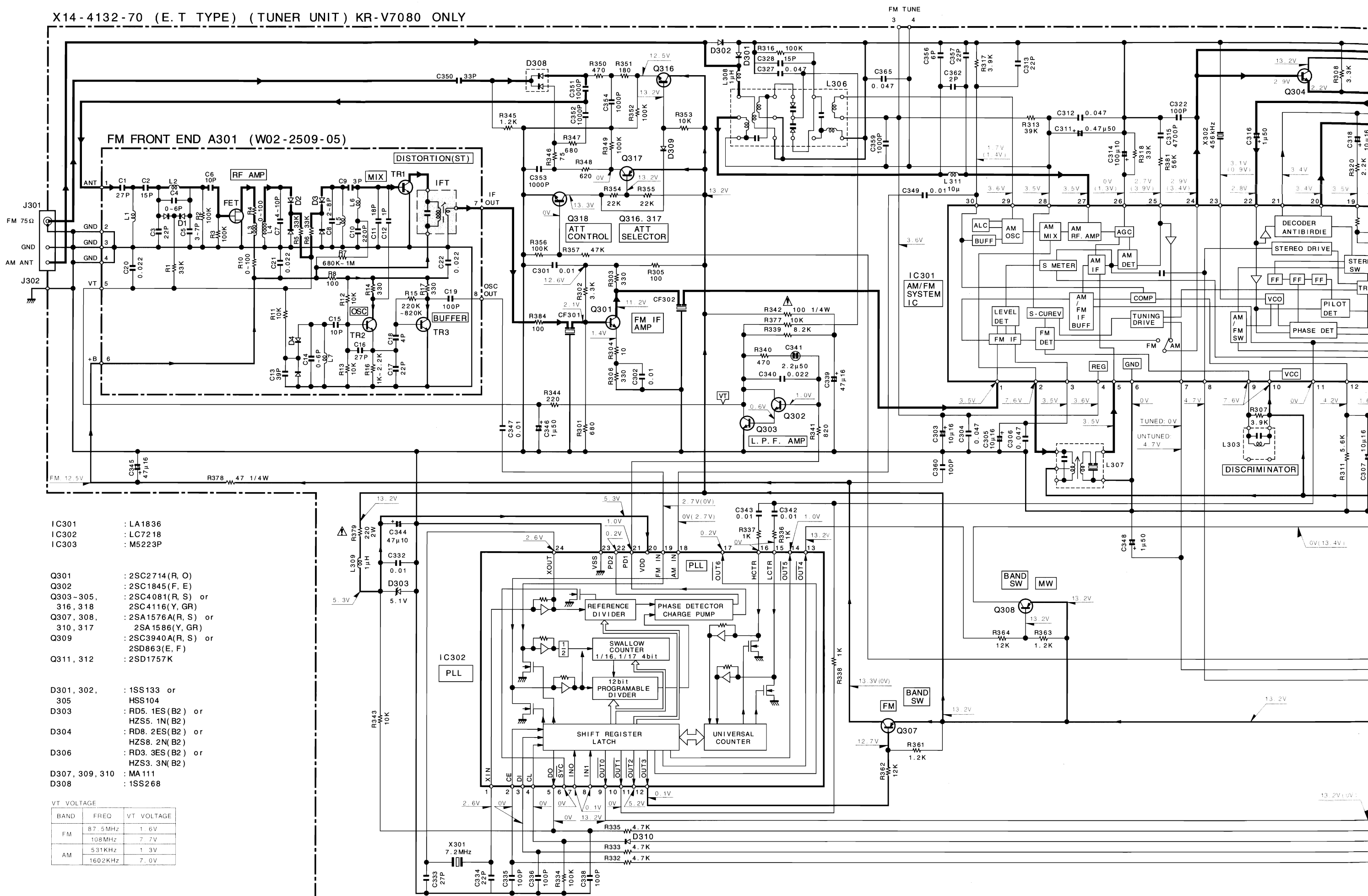

- IC301 : LA1836
- IC302 : LC7218
- IC303 : M5223P

- Q301 : 2SC2714 (R, O)
- Q302 : 2SC1845 (F, E)
- Q303-305, 316, 318 : 2SC4081 (R, S) or 2SC4116 (Y, GR)
- Q307, 308, 310, 317 : 2SA1576A (R, S) or 2SA1586 (Y, GR)
- Q309 : 2SC3940A (R, S) or 2SD863 (E, F)
- Q311, 312 : 2SD1757K

- D301, 302, 305 : 1SS133 or HSS104
- D303 : RD5. 1ES (B2) or HZS5. 1N (B2)
- D304 : RD8. 2ES (B2) or HZS8. 2N (B2)
- D306 : RD3. 3ES (B2) or HZS3. 3N (B2)
- D307, 309, 310 : MA111
- D308 : 1SS268

VT VOLTAGE

BAND	FREQ	VT VOLTAGE
FM	87.5MHz	1.6V
	108MHz	7.7V
AM	531KHz	1.3V
	1602KHz	7.0V

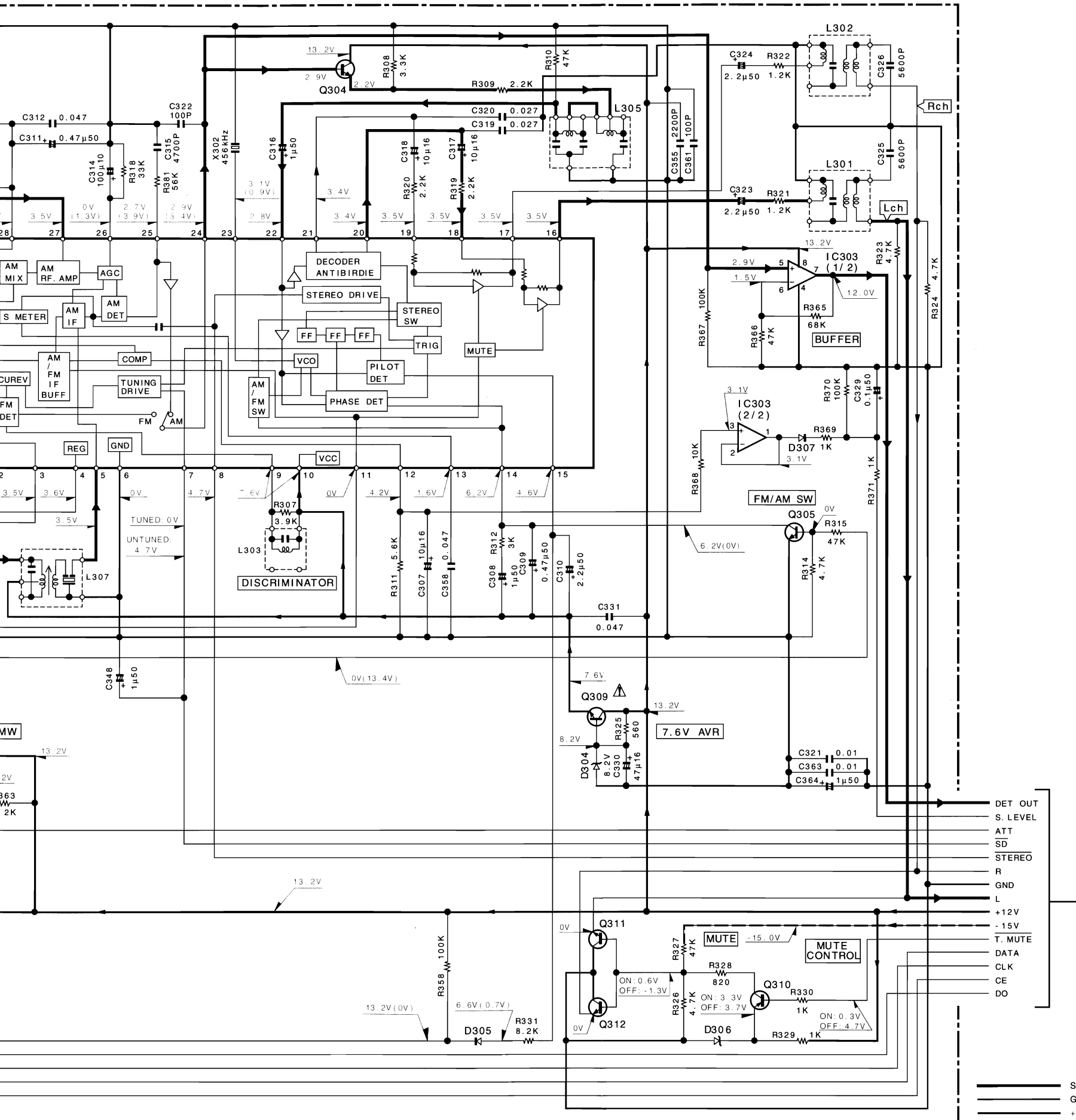

TO X14
KR-V7080
A 3/5

CAUTION: For continued safety, replace safety critical components only with manufacturer's recommended parts (refer to parts list). ⚠ indicates safety critical components. For continued protection against risk of fire, replace only with same type and rating fuse(s). To reduce the risk of electric shock, leakage-current or resistance measurements shall be carried out (exposed parts are acceptably insulated from the supply circuit) before the appliance is returned to the customer.

The DC voltage is an actual reading measured with a high impedance type voltmeter as the AM/FM signal generator is specified to the conditions as shown in the list below. The measurement value may vary depending on the measuring instruments used or on the product. The value shown in () is actual reading measured in the AM mode.

MODE	CARRIER	MODULATION		ANT INPUT
		FREQUENCY	DEVIATION	
FM	98MHz	1kHz	STEREO 67.5kHz 7.5kHz(Pilot)	60dB
AM	1000(999)kHz	400Hz	MONO 30% MOD	60dB

— SIGNAL LINE
— GND LINE
— +B LINE
- - - -B LINE

- IC1 : NJM4580L-D Q2, 15-18 : 2SC2878(B) Q6 : 2SB1370(E, F) or 2SB1375
 IC2 : NJM4565L-D 49, 50 Q8, 14 : 2SA1048(Y, GR) or 2SA1309A(Q, R)
 IC3 : NJM4580D-Q3 : 2SD2061(E, F) or 2SD2012 Q9 : 2SA1534A(R, S)
 IC4 : NJU7312AL Q3 : 2SD2061(E, F) or 2SD2012 Q10-12 : UN4219 or DTC113ZS
 IC5 : NJU7311AL Q5 : 2SC2458(Y, GR) or 2SC3311A(Q, R) Q19, 90 : UN4212 or DTC124ES
 IC6 : TDA7315 Q5, 7, 20 : 2SC2458(Y, GR) or 2SC3311A(Q, R) Q21-24, 33-36 : 2SA992(F, E)
 IC7 : TDA7345D Q5, 7, 20 : 2SC2458(Y, GR) or 2SC3311A(Q, R) Q47, 48 : 2SC2631(R, S)
 Q25-28, 37-40 : 2SC2631(R, S)

X90-434x-xx (A/4)
 X90-3010-20 (M TYPE)
 X90-3013-01 (C TYPE)

TO X14 CN503
 TO X90 CN503

- Q29, 30, 41, 42 : 2SA1123(R, S) D1 : RBV-602LFA
 Q31, 32, 43-46 : 2SC1845(F, E) D3-8, 31, 32 : S5688B or 1SR139-100
 Q63 : 2SC2003(L, K) D9 : RD4.7ES(B2) or HZS4.7N(B2)
 Q64 : 2SC3940A(R, S) D10, 15-20 : HSS104 or 55.56.64
 D11, 54 : RD6.2ES(B2) or HZS6.2N(B2)
 D12, 71, 72 : RD8.2ES(B2) or HZS8.2N(B2)
 D13, 14 : RD16ES(B2) or HZS16N(B2)
 D21-24, 29, 49 : HSS104A or ISS131
 D25, 30, 80 : RD5.1ES(B2) or HZS5.1N(B2)
 D57 : RD2.7ES(B2) or HZS2.7N(B2)
 D73 : RD10ES(B) or HZS10N(B)

- Q101, 102 : 2SD2222*5
 Q103, 104 : 2SB1470*5
 Q105, 106 : 2SC4137F50(V, W)
 Q111, 112 : 2SD2389
 Q107, 108 : 2SB1559

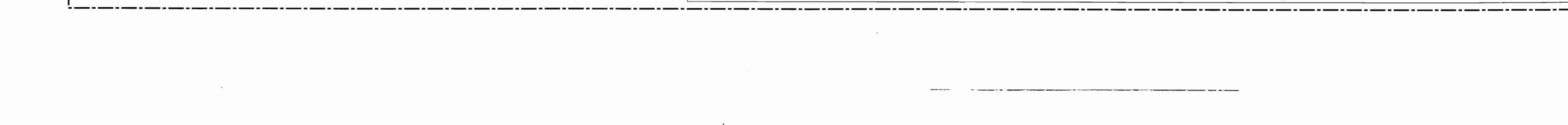
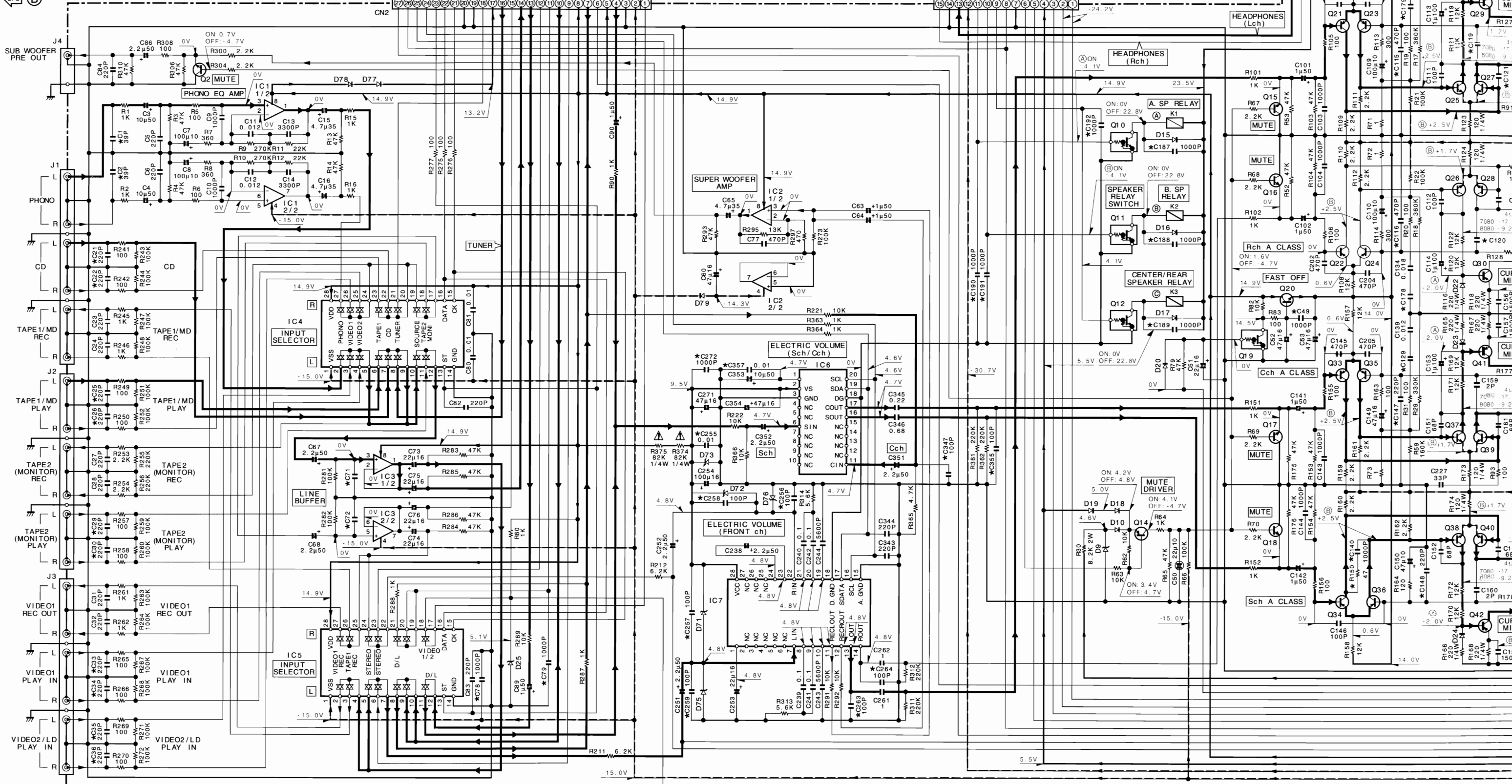

- 11, 42 : 2SA1123(R, S)
- 13-46 : 2SC1845(F, E)
- : 2SC2003(L, K)
- : 2SC3940A(R, S)
- : 2SD2222*5
- : 2SB1470*5
- : 2SC1437F50(V, W)
- : 2SD2389
- : 2SB1559
- D1 : RBV-602LFA
- D3-8, 31, 32 : S5688B or 1SR139-100
- 50-53, 77, 78 : RD4. 7ES(B2) or HZS4. 7N(B2)
- D9 : RD4. 7ES(B2) or HZS4. 7N(B2)
- D10, 15-20 : HSS104 or 48, 59, 79, 90 1SS133
- D11, 54 : RD6. 2ES(B2) or HZS6. 2N(B2)
- D12, 71, 72 : RD8. 2ES(B2) or HZS8. 2N(B2)
- 75, 76 : RD16ES(B2) or HZS16N(B2)
- D13, 14 : HSS104 or 1SS131
- D21-24, 29, 49 : 55, 56, 64
- D25, 30, 80 : RD5. 1ES(B2) or HZS5. 1N(B2)
- D57 : RD2. 7ES(B2) or HZS2. 7N(B2)
- D73 : RD10ES(B) or HZS10N(B)

- HP. R
- HP. L
- HP. GND
- SP. A
- SP. B
- SP. CS
- POW
- D. GND
- MUTE
- 4/8
- +5.6V
- F. OFF
- FIL
- 24.2V

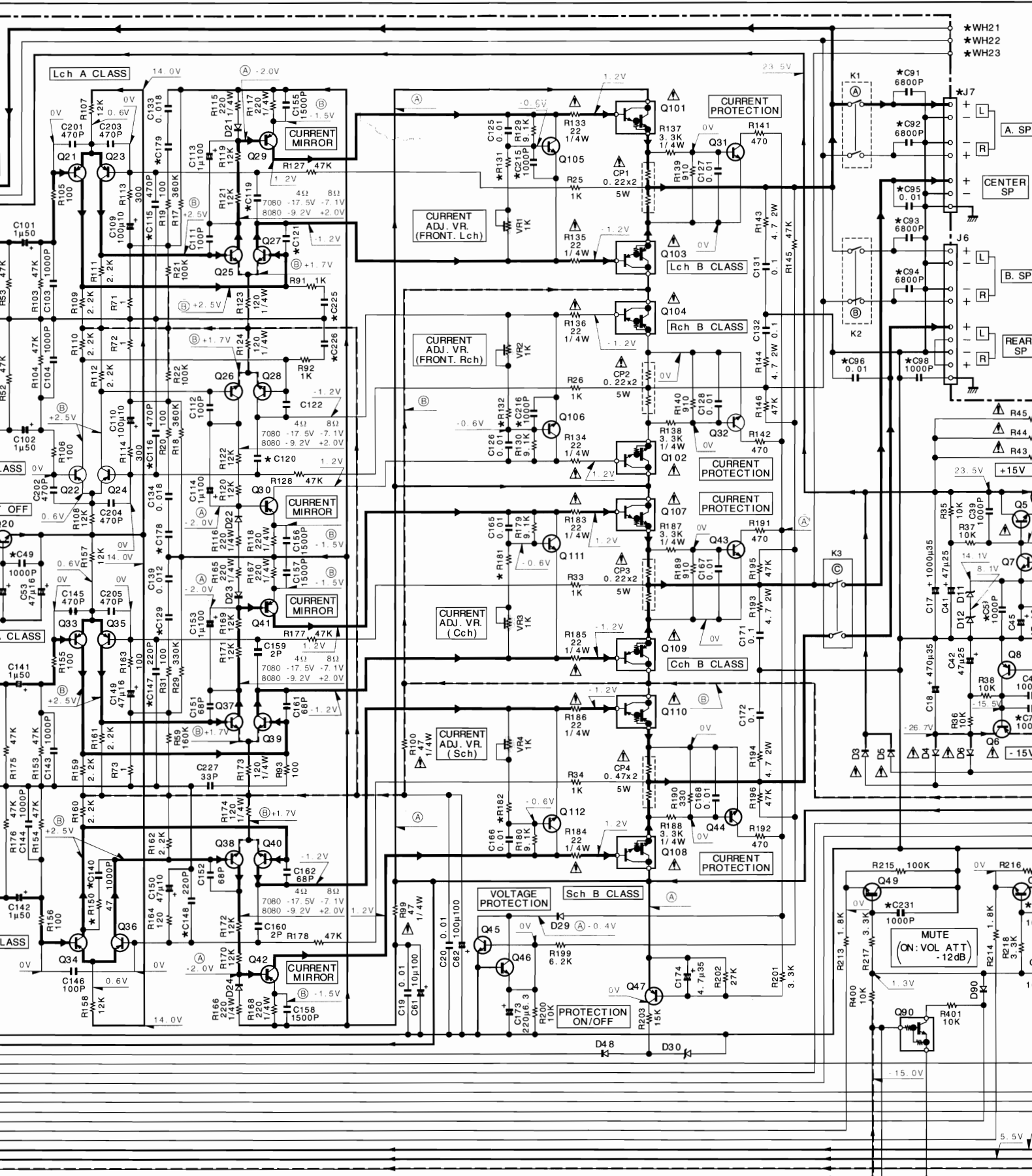

X09-434x-xx
[X90-301x-xx (0-20: M, 3-01: C)]

MODEL NAME	DESTINATION		UNIT NO.	C1, 2	C3
	COUNTRY	ABB.			
KR-V 7080	U. S. A.	K	0-10	YES	
	CANADA	P	0-10	YES	
	PX	Y	2-91	NO	
	AUSTRALIA	X	0-71	NO	
	EUROPE	E	2-71	NO	
KR-V 8080	GENERAL MARKET	M	0-21	YES	
	CHI NA	C	3-01	YES	
KR-V 7080	U. S. A.	K	0-11	NO	
	CANADA	P	0-11	NO	

MODEL NAME	ABB.	UNIT NO.	CN10	R131, 132	R150
KR-V 7080	K	0-10	NO	2.7K	NO
	P	0-10	NO	2.7K	NO
	Y	2-91	YES	3.0K	YES
	X	0-71	NO	3.0K	YES
	T	0-51	NO	3.0K	YES
KR-V 8080	E	2-71	YES	2.7K	NO
	C	3-01	NO	2.7K	NO

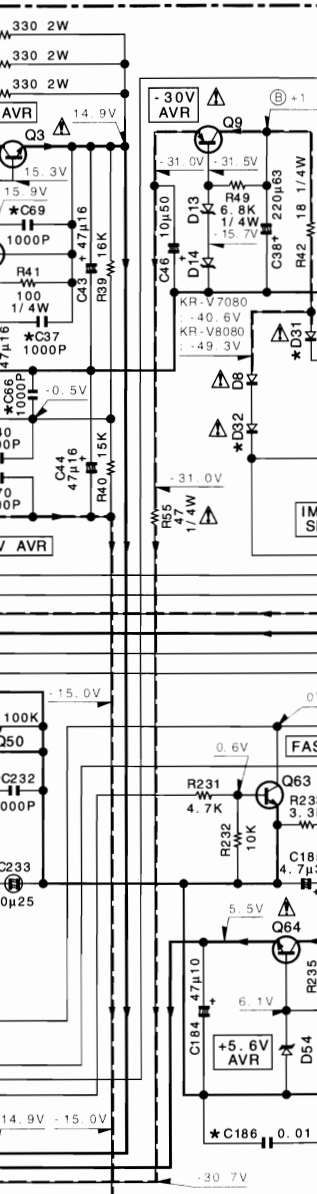
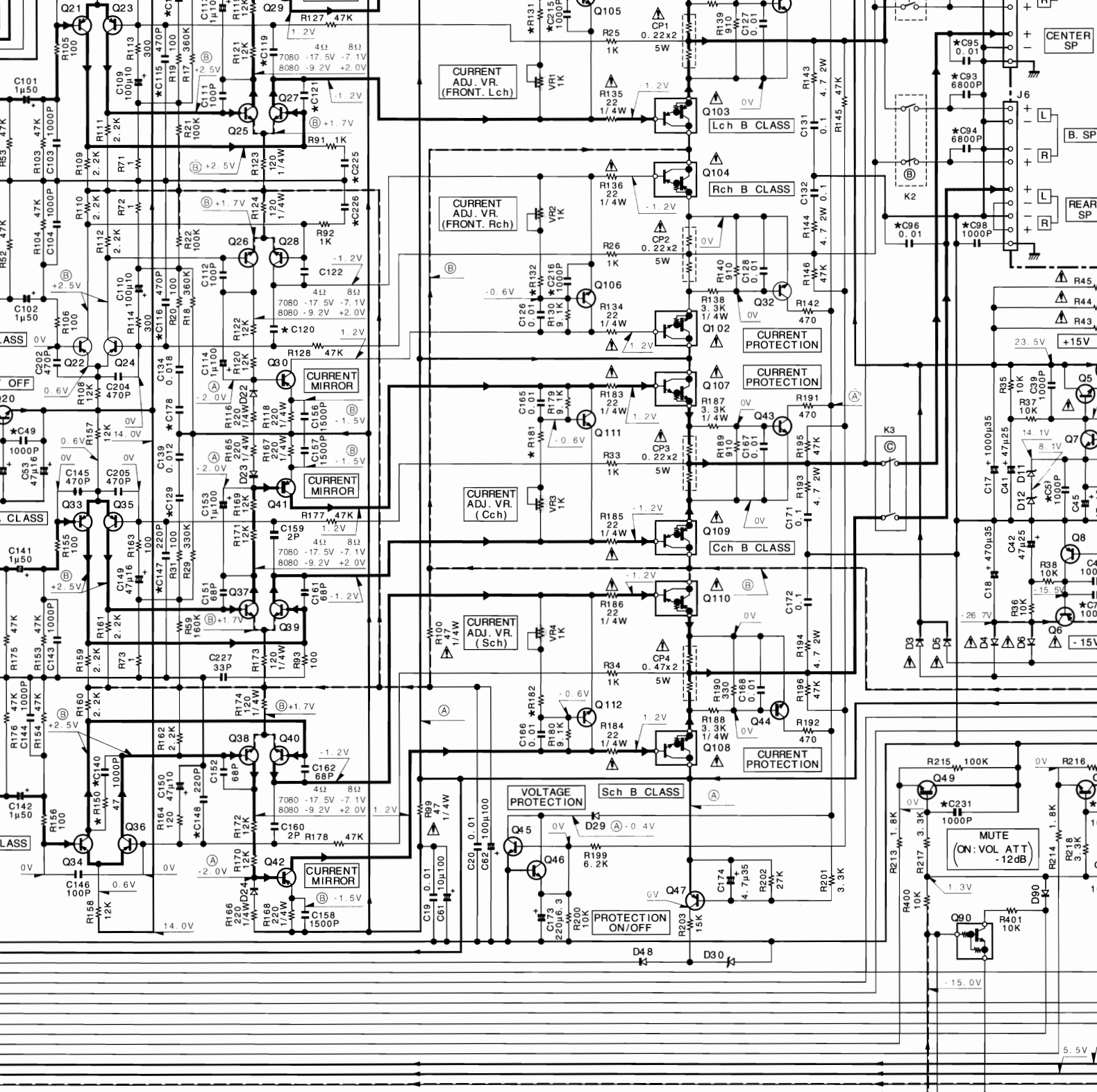
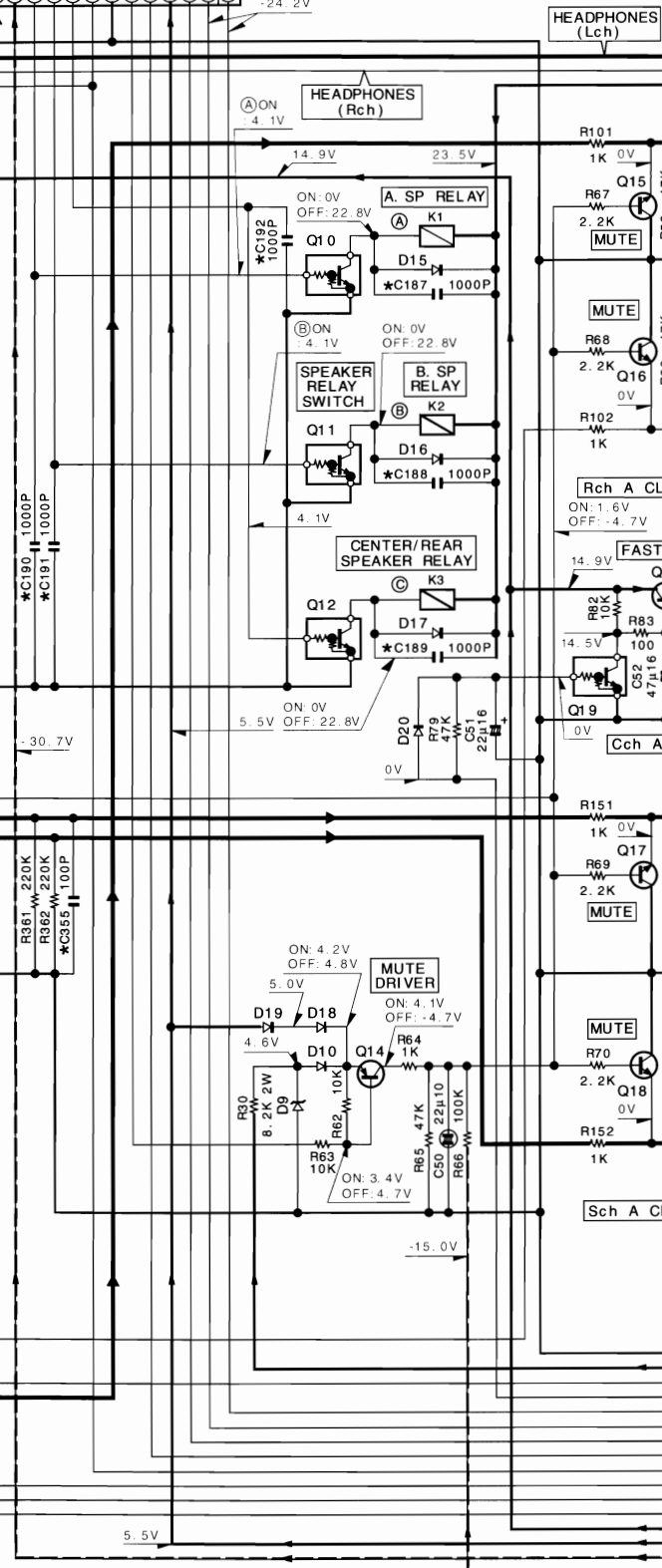
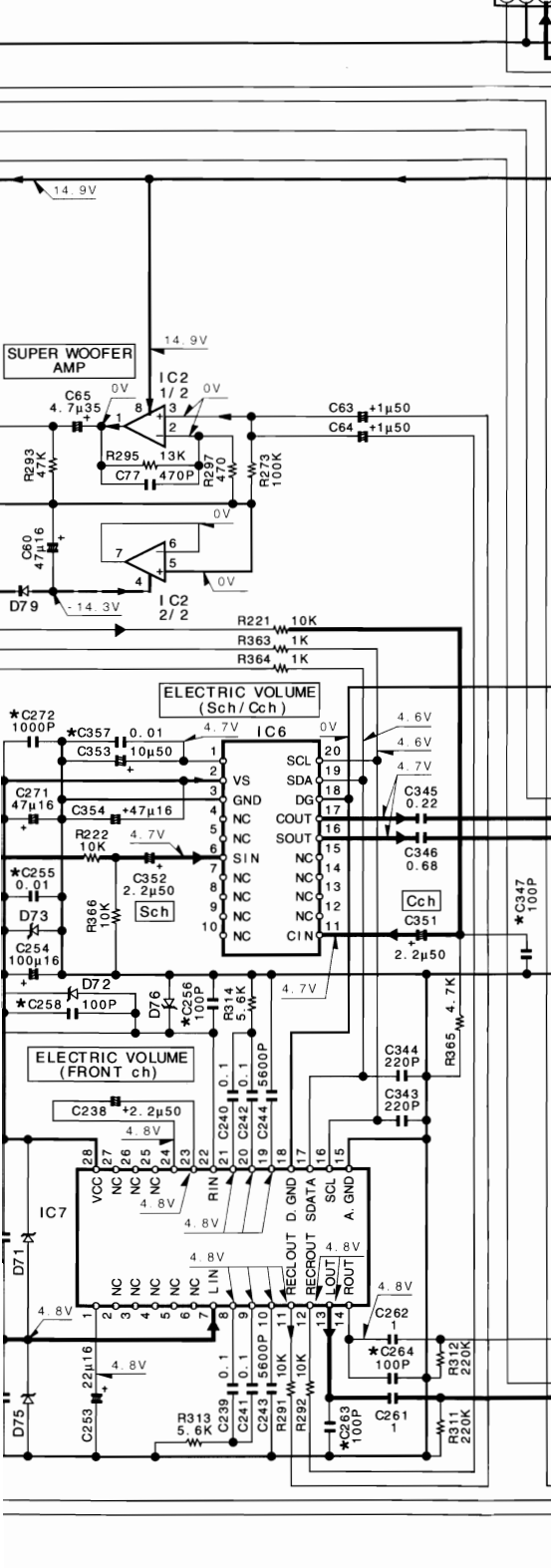

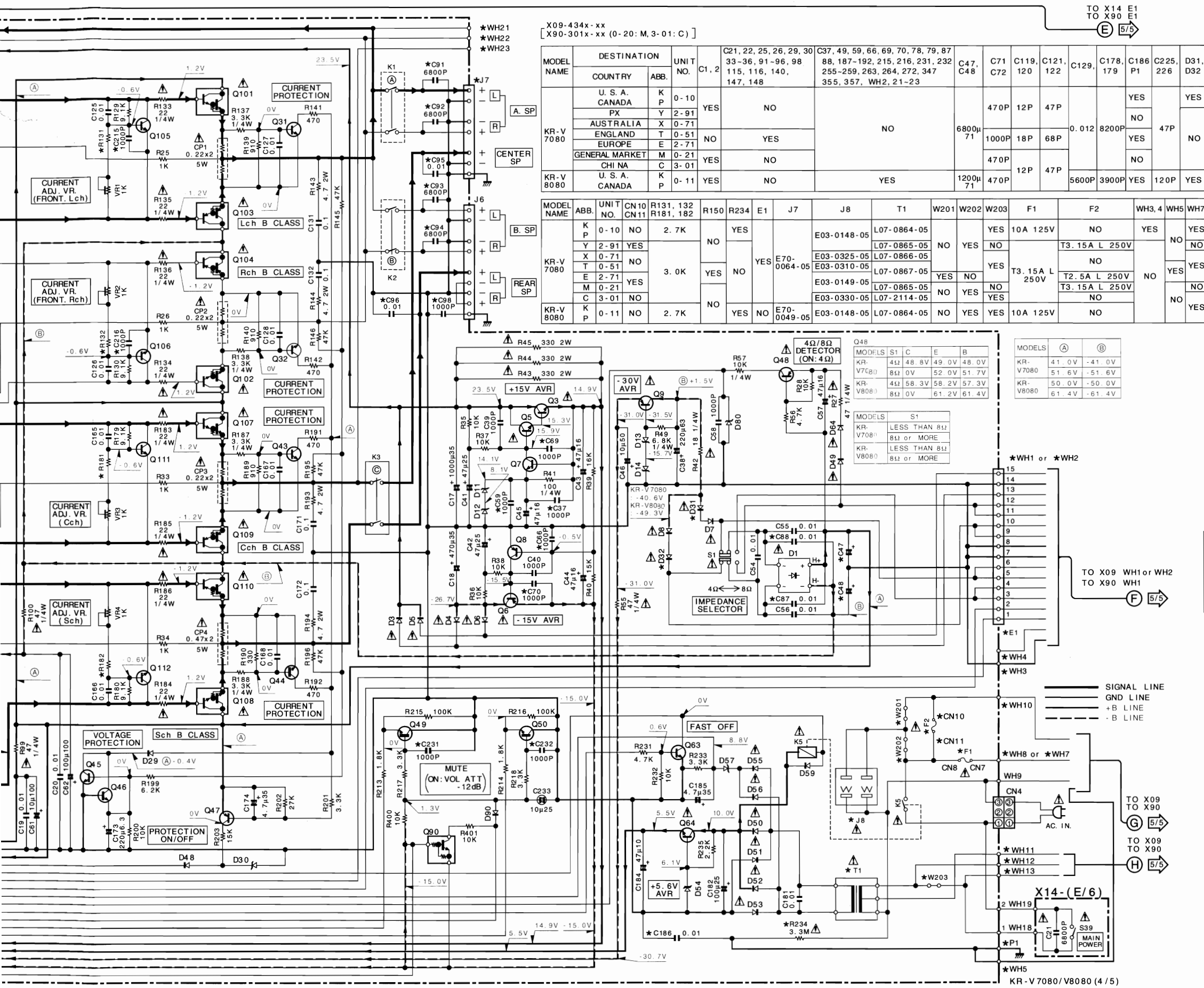

X09-434x-xx
X90-301x-xx (0-20: M, 3-01: C)

MODEL NAME	DESTINATION	UNIT NO.	C1, 2	C21, 22, 25, 26, 29, 30	C37, 49, 59, 66, 69, 70, 78, 79, 87	C47, C48	C71, C72	C119, 120	C121, 122	C129,	C178, 179	C186 P1	C225, 226	D31, D32	
KR-V 7080	U. S. A.	K	0-10	NO	NO	NO	470P	12P	47P	0.012	8200P	NO	47P	YES	
	CANADA	P	2-91	YES	NO	NO	1000P	18P	68P	NO	NO	NO	NO	NO	
	AUSTRALIA	X	0-71	NO	YES	NO	470P	12P	47P	NO	NO	NO	NO	NO	
	ENGLAND	T	0-51	NO	YES	NO	470P	12P	47P	NO	NO	NO	NO	NO	
	EUROPE	E	2-71	YES	NO	NO	1200μ	470P	12P	47P	5600P	3900P	YES	120P	YES
GENERAL MARKET	M	0-21	YES	NO	NO	NO	NO	NO	NO	NO	NO	NO	NO	NO	
CHI NA	C	3-01	NO	NO	NO	NO	NO	NO	NO	NO	NO	NO	NO	NO	
KR-V 8080	U. S. A.	K	0-11	YES	NO	YES	1200μ	470P	12P	47P	5600P	3900P	YES	120P	YES

MODEL NAME	ABB.	UNIT NO.	CN 10, CN 11	R131, 132, R181, 182	R150	R234	E1	J7	J8	T1	W201	W202	W203	F1	F2	WH3, 4	WH5	WH7	WH8, 10-13
KR-V 7080	K P	0-10	NO	2.7K	NO	YES	NO	NO	E03-0148-05	L07-0864-05	NO	YES	NO	10A 125V	NO	YES	NO	YES	NO
	Y	2-91	YES	NO	NO	NO	NO	NO	E03-0325-05	L07-0865-05	NO	YES	NO	NO	T3.15A L 250V	NO	NO	NO	YES
	X	0-71	NO	3.0K	YES	NO	YES	E70-0064-05	E03-0310-05	L07-0866-05	NO	NO	YES	T3.15A L 250V	NO	NO	YES	NO	
	T	0-51	NO	NO	NO	NO	NO	NO	E03-0149-05	L07-0867-05	NO	NO	NO	NO	T2.5A L 250V	NO	NO	NO	YES
	E	2-71	YES	NO	NO	NO	NO	NO	E03-0330-05	L07-2114-05	NO	YES	NO	NO	NO	NO	NO	NO	YES
M	0-21	NO	NO	NO	NO	NO	NO	NO	E03-0330-05	L07-2114-05	NO	YES	NO	NO	NO	NO	NO	NO	YES
C	3-01	NO	NO	2.7K	NO	NO	NO	NO	E03-0330-05	L07-2114-05	NO	YES	NO	NO	NO	NO	NO	NO	YES
KR-V 8080	K P	0-11	NO	2.7K	NO	YES	NO	NO	E70-0049-05	E03-0148-05	L07-0864-05	NO	YES	YES	10A 125V	NO	NO	NO	NO

CAUTION: For continued safety, replace safety critical components only with manufacturer's recommended parts (refer to parts list). ⚠ indicates safety critical components. For continued protection against risk of fire, replace only with same type and rating fuse(s). To reduce the risk of electric shock, leakage-current or resistance measurements shall be carried out (exposed parts are acceptably insulated from the supply circuit) before the appliance is returned to the customer.

The DC voltage is an actual reading measured with a high impedance type voltmeter as the AM/FM signal generator is specified to the conditions as shown in the list below. The measurement value may vary depending on the measuring instruments used or on the product. The value shown in () is actual reading measured in the AM mode.

MODE	CARRIER	MODULATION		ANT INPUT
		FREQUENCY	DEVIATION	
FM	98MHz	1kHz	STEREO 67.5kHz 7.5kHz(Pilot)	60dB
AM	1000(999)kHz	400Hz	MONO 30% MOD	60dB

TO X14
TO X90
KR-V7080/V8080

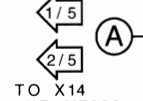

X14-41xx-xx (B/6) [X90-3010-20 (M) X90-3013-01 (C)] (SURROUND UNIT)

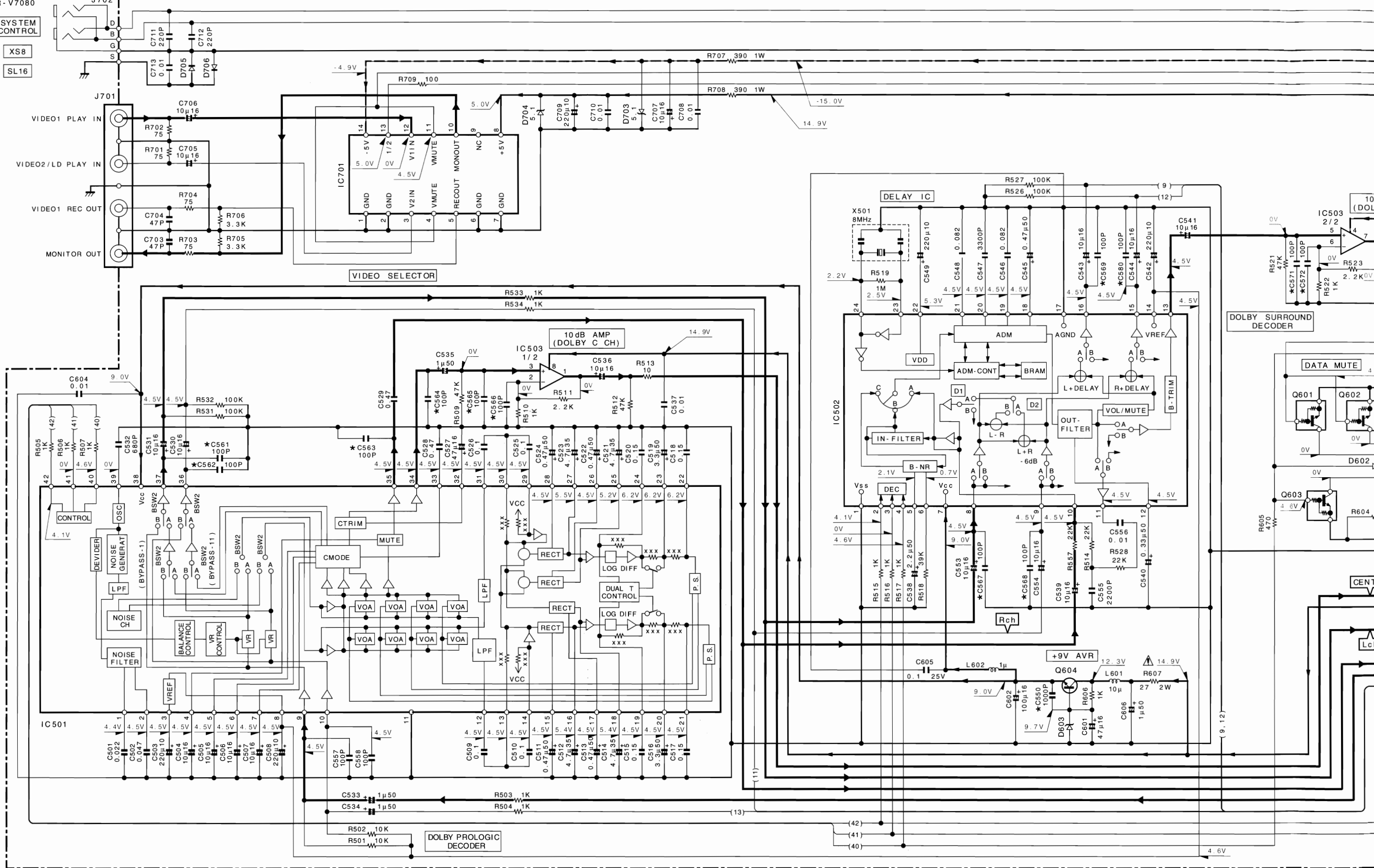

2

3

4

5

6

7

ND UNIT)

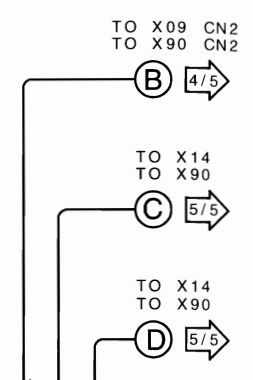
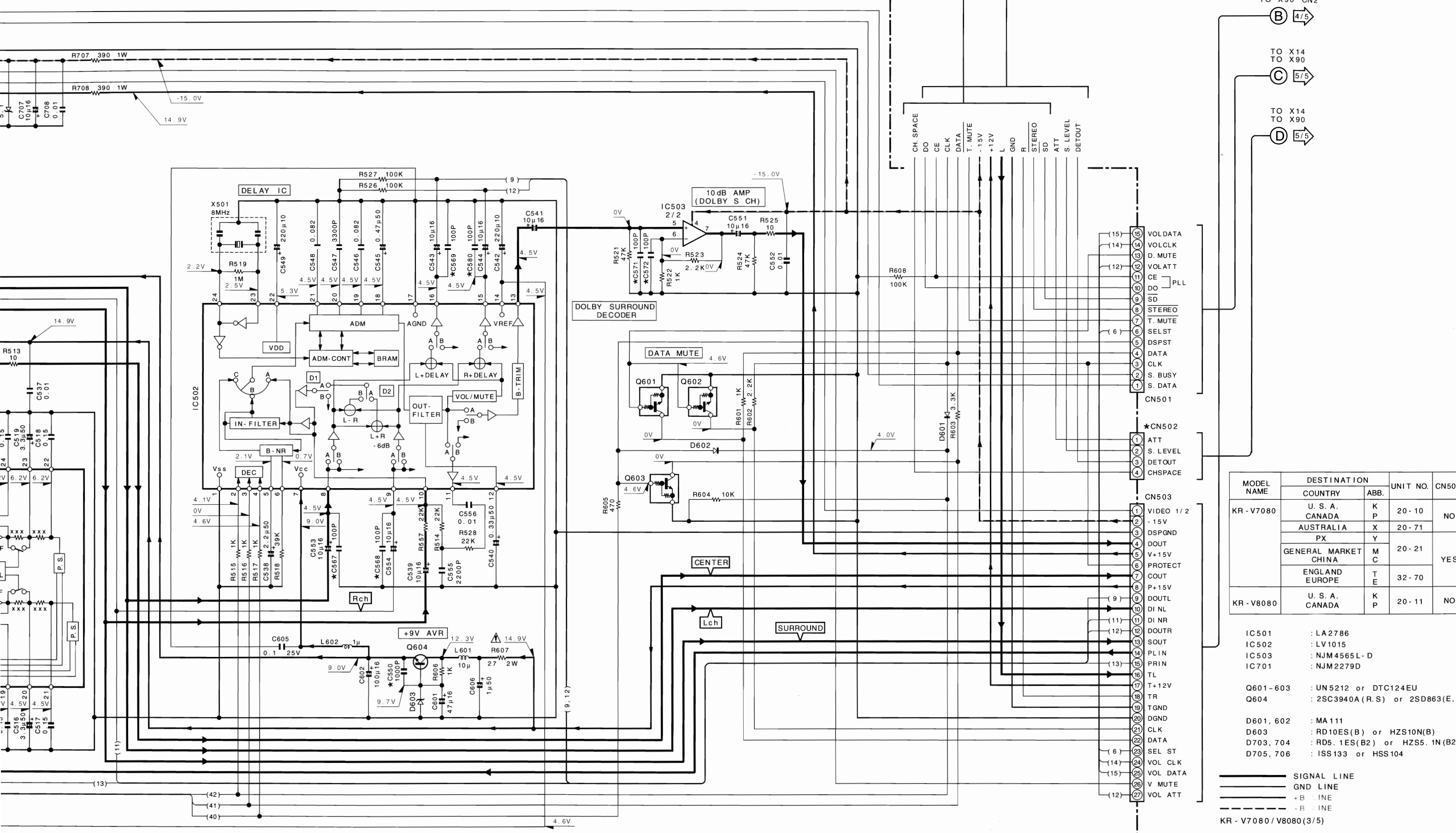

MODEL NAME	DESTINATION		UNIT NO.	CN501
	COUNTRY	ABB.		
KR - V7080	U. S. A.	K	20 - 10	NO
	CANADA	P		
	AUSTRALIA	X	20 - 71	
	PX	Y		
KR - V8080	GENERAL MARKET		20 - 21	YES
	CHINA	M		
	ENGLAND	T	32 - 70	
KR - V8080	U. S. A.	K	20 - 11	NO
	CANADA	P		

- IC 501 : LA 2786
- IC 502 : LV 1015
- IC 503 : NJM 4565 L - D
- IC 701 : NJM 2279 D
- Q601 - 603 : UN 5212 or DTC 124 EU
- Q604 : 2SC 3940 A (R. S) or 2SD 863 (E.)
- D601, 602 : MA 111
- D603 : RD 10ES (B) or HZS 10N (B)
- D703, 704 : RD 5.1ES (B2) or HZS 5.1N (B2)
- D705, 706 : ISS 133 or HSS 104

——— SIGNAL LINE
 - - - - - GND LINE
 +B LINE
 - -B LINE
 KR - V7080 / V8080 (3/5)

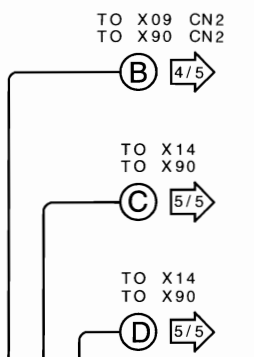
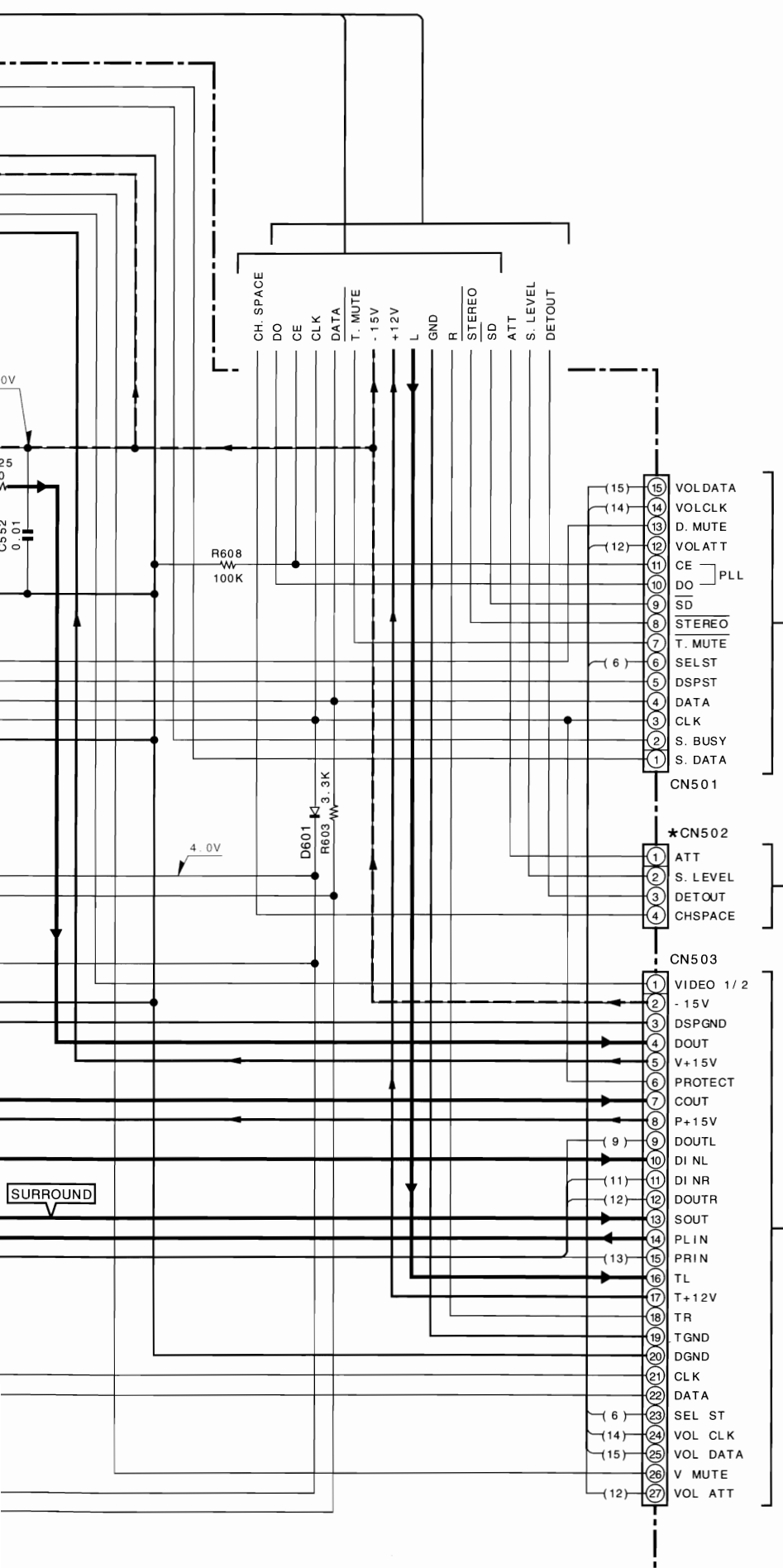

- (15) VOL DATA
- (14) VOL CLK
- (13) D. MUTE
- (12) VOL ATT
- (11) VOL ATT
- (10) CE } PLL
- (9) DO } PLL
- (8) SD
- (7) STEREO
- (6) T. MUTE
- (5) SEL ST
- (4) DSPST
- (3) DATA
- (2) CLK
- (1) S. BUSY
- (0) S. DATA
- CN501
- *CN502
- (1) ATT
- (2) S. LEVEL
- (3) DETOUT
- (4) CHSPACE
- CN503
- (1) VIDEO 1/2
- (2) -15V
- (3) DSPGND
- (4) DOUT
- (5) V+15V
- (6) PROTECT
- (7) COUT
- (8) P+15V
- (9) DOUTL
- (10) DI NL
- (11) DI NR
- (12) DOUTR
- (13) SOUT
- (14) PLIN
- (15) PRIN
- (16) TL
- (17) T+12V
- (18) TR
- (19) TGND
- (20) DGND
- (21) CLK
- (22) DATA
- (23) SEL ST
- (24) VOL CLK
- (25) VOL DATA
- (26) V MUTE
- (27) VOL ATT

MODEL NAME	DESTINATION		UNIT NO.	CN502	C550, C561-572
	COUNTRY	ABB.			
KR - V7080	U. S. A.	K	20 - 10	NO	YES
	CANADA	P			
	AUSTRALIA	X	20 - 71		
	PX	Y			
KR - V8080	GENERAL MARKET	M	20 - 21	YES	NO
	CHINA	C			
	ENGLAND	T			
KR - V8080	EUROPE	E	32 - 70	NO	YES
	U. S. A.	K			
	CANADA	P			

- IC501 : LA2786
- IC502 : LV1015
- IC503 : NJM4565L-D
- IC701 : NJM2279D
- Q601-603 : UN5212 or DTC124EU
- Q604 : 2SC3940A (R.S) or 2SD863(E, F)
- D601, 602 : MA111
- D603 : RD10ES(B) or HZS10N(B)
- D703, 704 : RD5.1ES(B2) or HZS5.1N(B2)
- D705, 706 : ISS133 or HSS104

——— SIGNAL LINE
 ——— GND LINE
 ——— +B LINE
 - - - -B LINE

KR - V7080 / V8080 (3/5)

CAUTION: For continued safety, replace safety critical components only with manufacturer's recommended parts (refer to parts list). 1 indicates safety critical components. For continued protection against risk of fire, replace only with same type and rating fuse(s). To reduce the risk of electric shock, leakage current or resistance measurements shall be carried out (exposed parts are acceptably insulated from the supply circuit) before the appliance is returned to the customer.

The DC voltage is an actual reading measured with a high impedance type voltmeter as the AM/FM signal generator is specified to the conditions as shown in the list below. The measurement value may vary depending on the measuring instruments used or on the product. The value shown in () is actual reading measured in the AM mode.

MODE	CARRIER	MODULATION		ANT INPUT
		FREQUENCY	DEVIATION	
FM	98MHz	1kHz	STEREO 67.5kHz 7.5kHz(Pilot)	60dB
AM	1000(999)kHz	400Hz	MONO 30% MOD	60dB

Y05-3090-10

KR-V7080/V8080
KENWOOD

X14-41XX-XX A/6 [X90-3010-20 (M) X90-3013-01 (C)] (DISPLAY UNIT)

TO X09 CN1 TO X90 CN1 (E)
TO X14 CN501 TO X90 CN501 (C)
TO X14 CN502 TO X90 CN502 (D)
TO X09 WH1 or WH2 TO X90 WH1 (F)
TO X09 TO X90 (G)
TO X09 TO X90 (H)

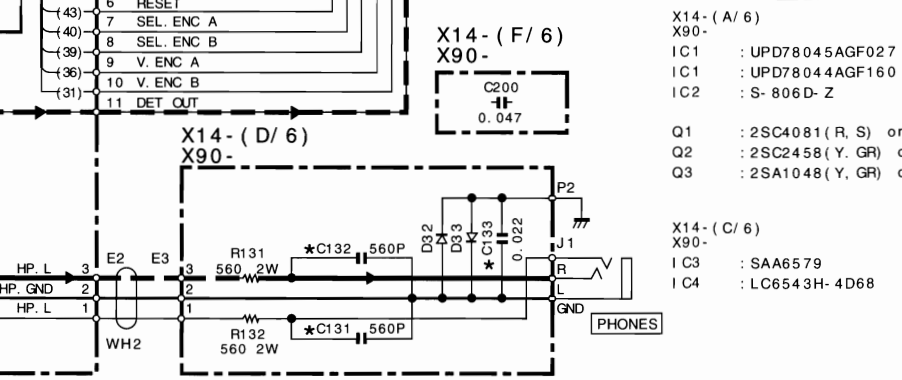
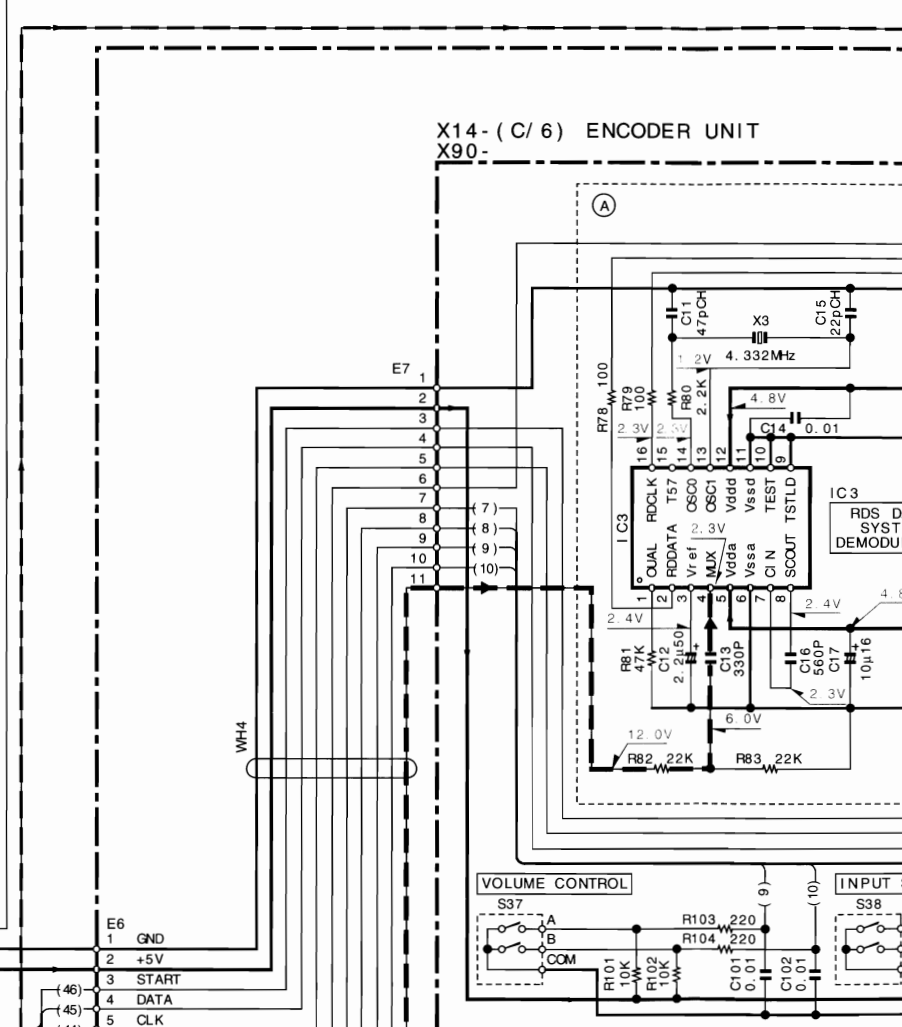
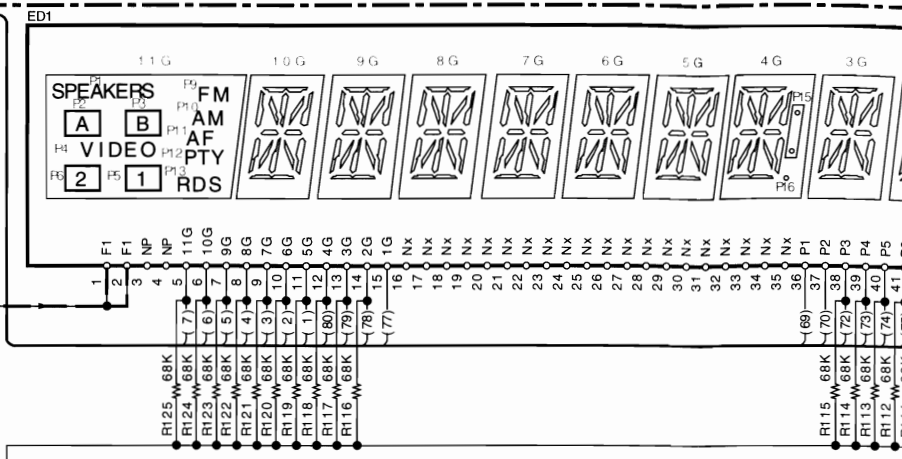
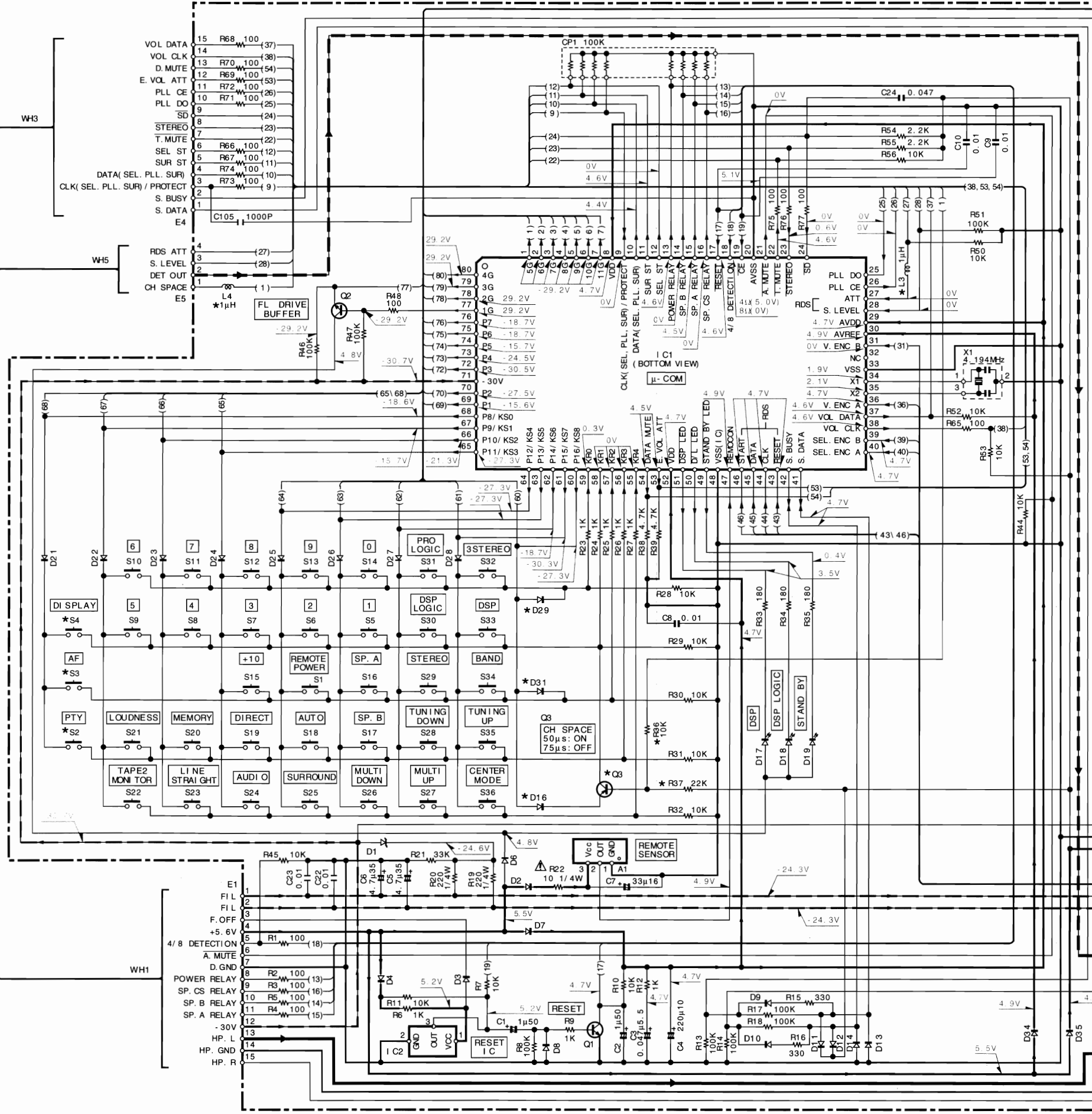

- X14-(A/6) X90- IC1: UPD78045AGF027, IC2: S-806D-Z, Q1: 2SC4081(R,S), Q2: 2SC2458(Y,GR), Q3: 2SA1048(Y,GR)
X14-(C/6) X90- IC3: SAA6579, IC4: LC6543H-4D68

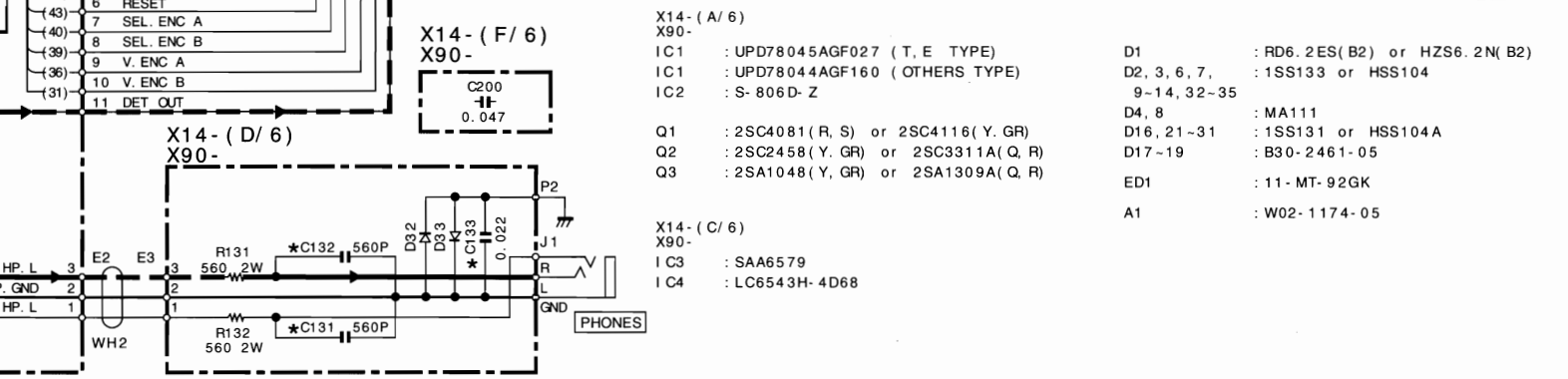
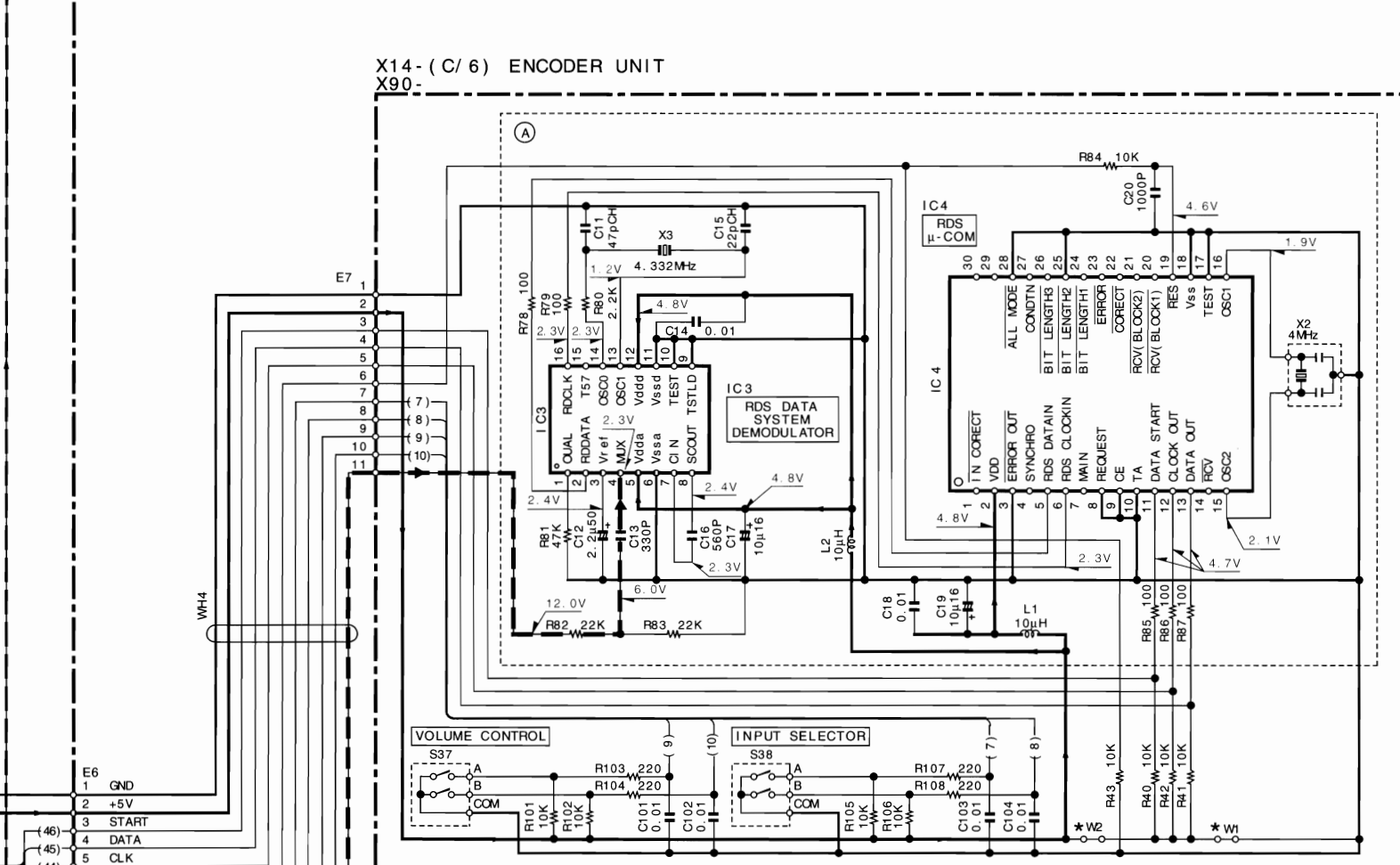
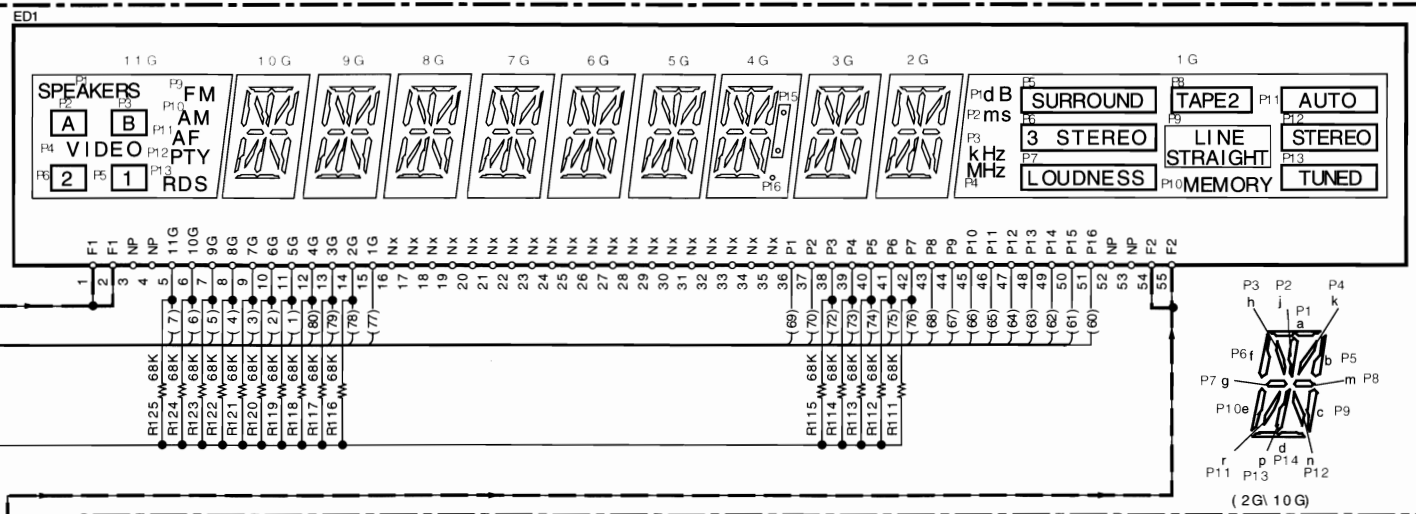
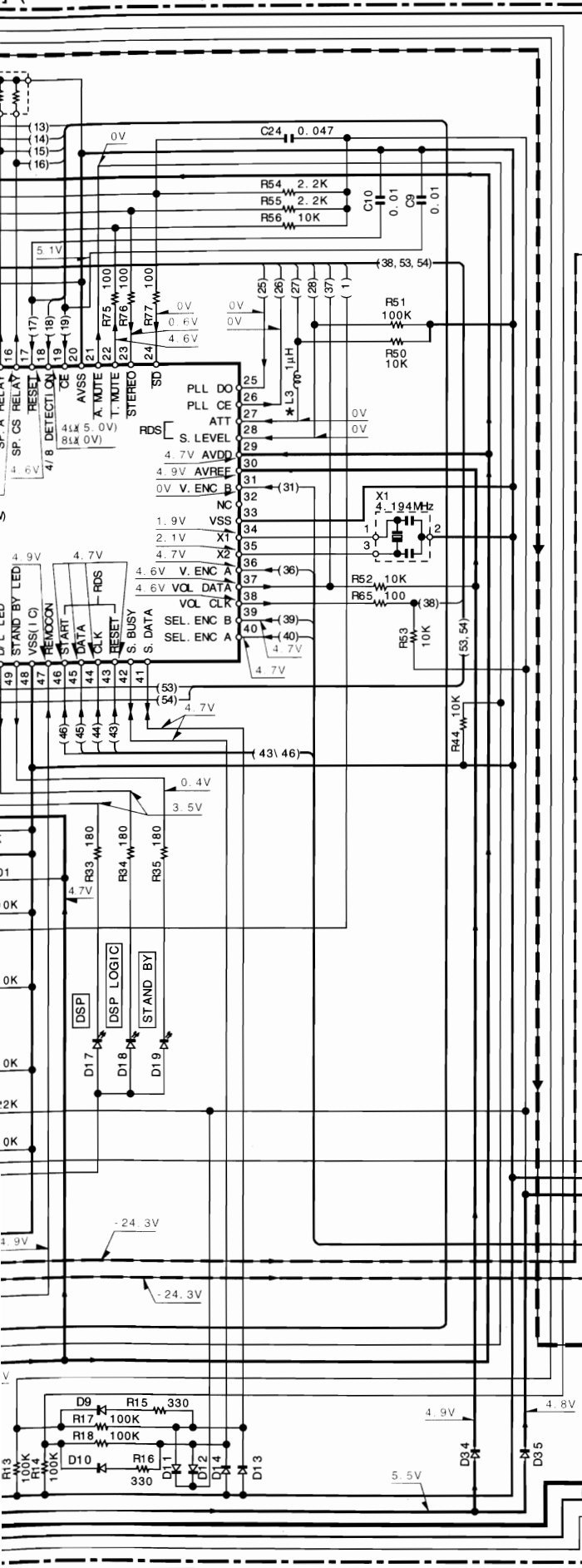

- X14 - (A/6) X90-**
- IC1 : UPD78045AGF027 (T, E TYPE)
 - IC2 : S-806D-Z
 - Q1 : 2SC4081(R, S) or 2SC4116(Y, GR)
 - Q2 : 2SC2458(Y, GR) or 2SC3311A(Q, R)
 - Q3 : 2SA1048(Y, GR) or 2SA1309A(Q, R)
 - D1 : RD6.2ES(B2) or HZS6.2N(B2)
 - D2, 3, 6, 7, 9-14, 32-35 : 1SS133 or HSS104
 - D4, 8 : MA111
 - D16, 21-31 : 1SS131 or HSS104A
 - D17-19 : B30-2461-05
 - ED1 : 11-MT-92GK
 - A1 : W02-1174-05
- X14 - (C/6) X90-**
- IC3 : SAA6579
 - IC4 : LC6543H-4D68

KR-V7080/V8080 K, P TYPE

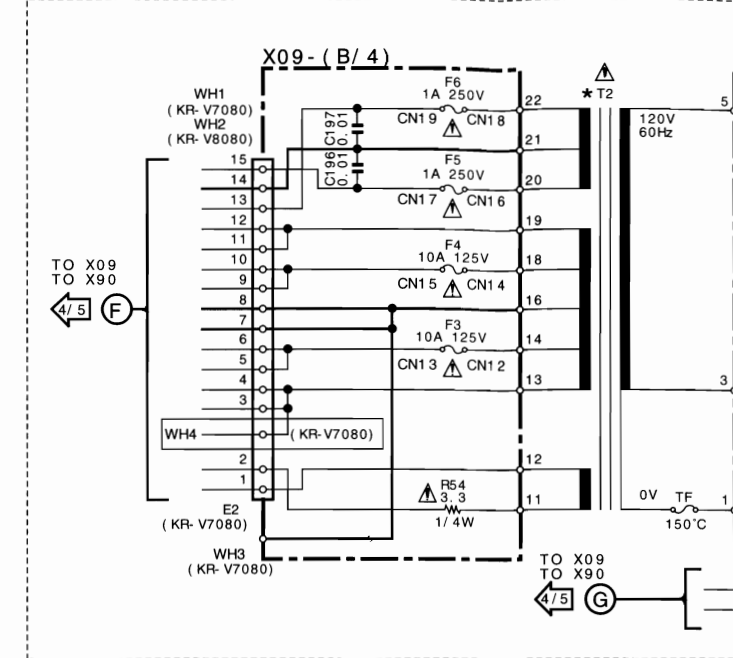

KR-V7080 T, E, X, C TYPE

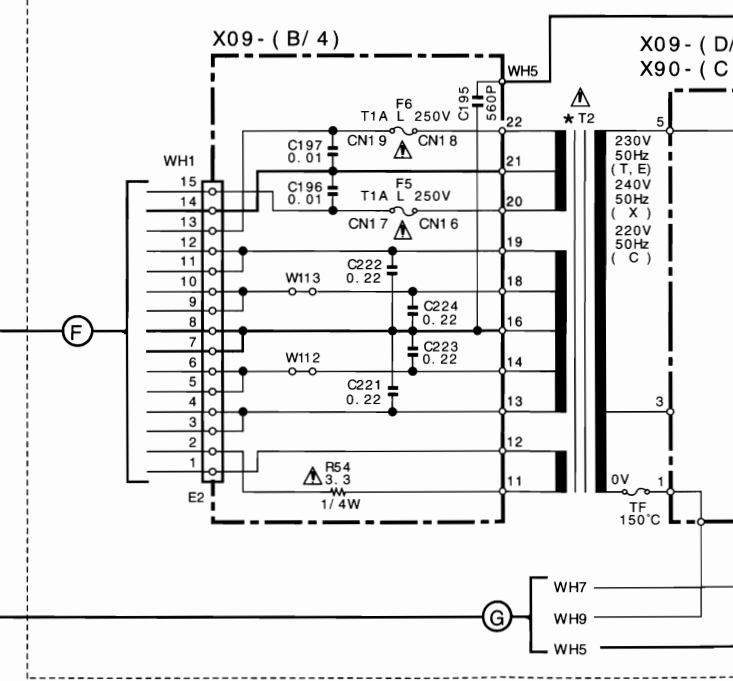

X14-41XX-XX(A/6), (C/6) X90-

MODEL NAME	DESTINATION COUNTRY	ABB.	UNIT NO.	D29	D31	D16 Q3	R36	R37	(A)	C131 C132	C133
KR-V7080	U. S. A.	K	20-10	NO	NO	NO	NO	NO			
	CANADA	P	20-10	NO	NO	NO	NO	NO			
	AUSTRALIA	X	20-71	YES	YES	NO	NO	NO	NO	NO	NO
KR-V8080	U. S. A.	K	20-11	NO	NO	NO	NO	NO			
	CANADA	P	20-11	NO	NO	NO	NO	NO			
	EUROPE	T	32-70	YES	YES	NO	NO	NO	YES	YES	YES

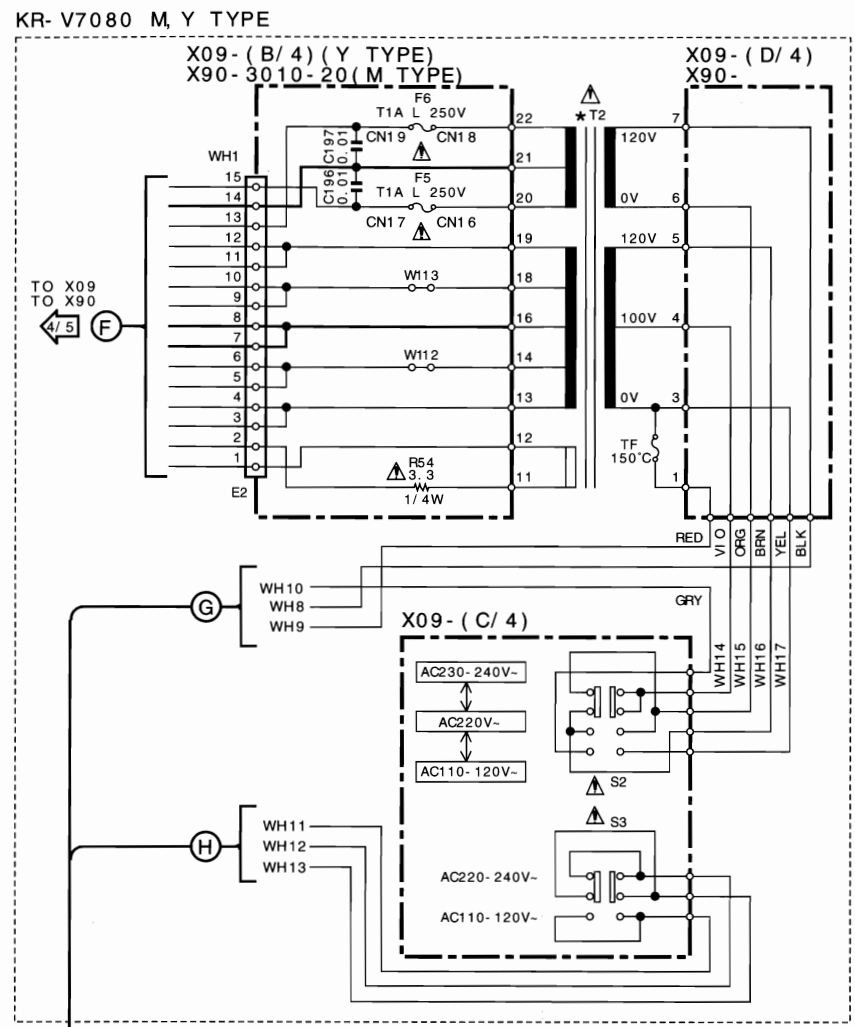
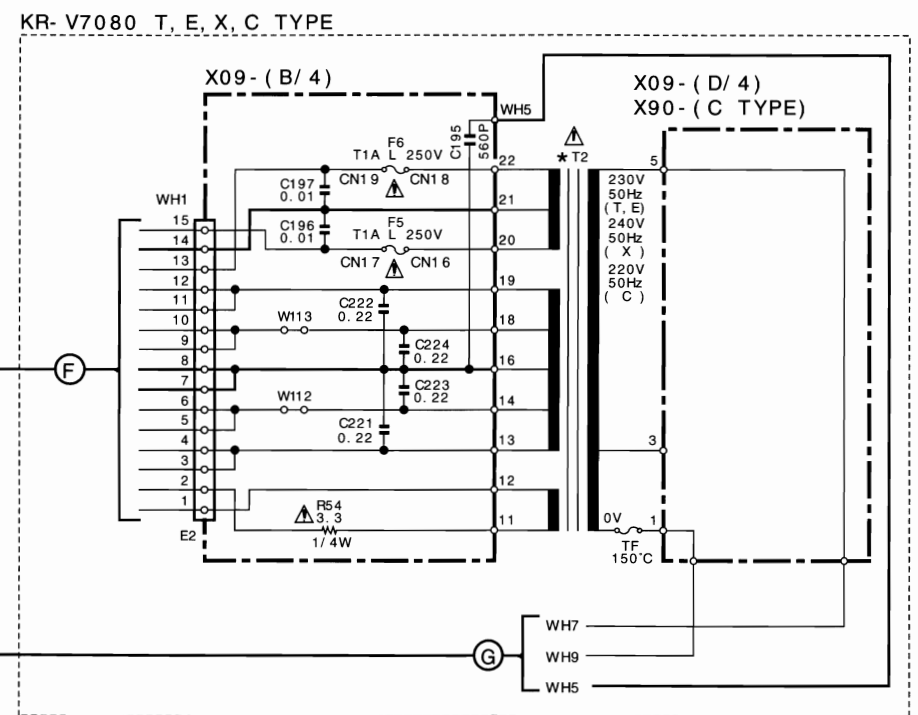
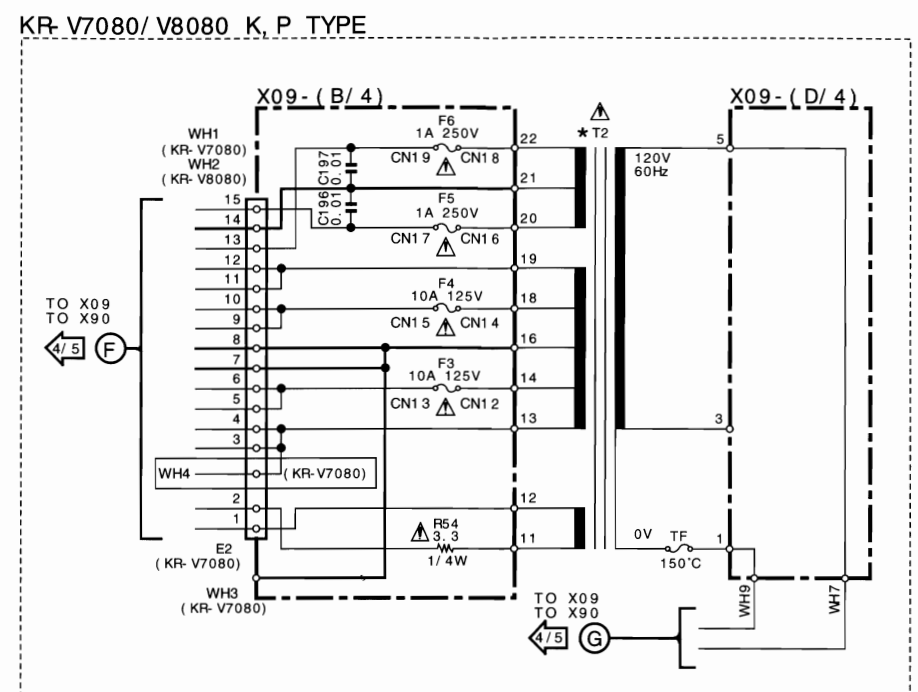
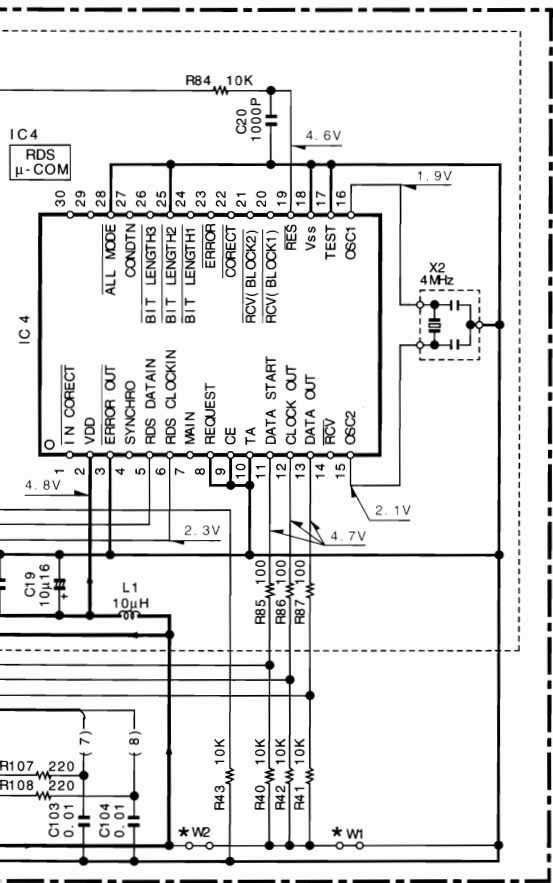
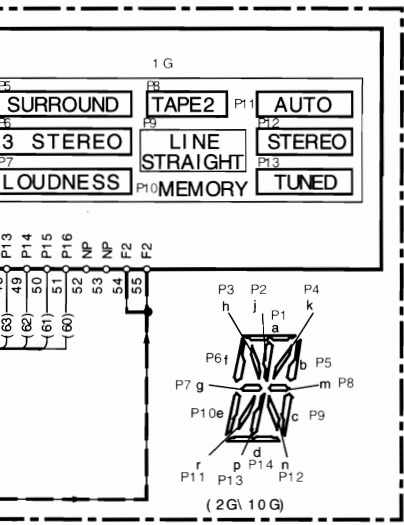

X09 - (B/4) (C/4)
X90 - (C, M TYPE)

MODEL NAME	DESTINATION		T2
	COUNTRY	ABB.	
KR-V7080	U. S. A.	K	L07-2059-05
	CANADA	P	
	AUSTRALIA	X	
	PX	Y	
	GENERAL MARKET	M	
KR-V8080	CHINA	C	L07-2146-05
	ENGLAND	T	L07-2142-05
	EUROPE	E	L07-2062-05
KR-V8080	U. S. A.	K	L07-2063-05
	CANADA	P	

CAUTION: For continued safety, replace safety critical components only with manufacturer's recommended parts (refer to parts list). Δ indicates safety critical components. For continued protection against risk of fire, replace only with same type and rating fuse(s). To reduce the risk of electric shock, leakage-current or resistance measurements shall be carried out (exposed parts are acceptably insulated from the supply circuit) before the appliance is returned to the customer.

The DC voltage is an actual reading measured with a high impedance type voltmeter as the AM/FM signal generator is specified to the conditions as shown in the list below. The measurement value may vary depending on the measuring instruments used or on the product. The value shown in () is actual reading measured in the AM mode.

X14-41XX-XX(A/6), (C/6)
X90-

MODEL NAME	DESTINATION	UNIT NQ	D29	D31	D16 Q3	R36	R37	(A)	C131 C132	C133	S2, 3, 4	W1	W2	L3	L4
KR-V7080	U. S. A.	K	20-10	NO	NO	NO	NO	NO	NO	NO	NO	YES	NO	NO	NO
	CANADA	P	20-10	NO	NO	NO	NO	NO	NO	NO	NO	YES	NO	NO	NO
	AUSTRALIA	X	20-71	YES	YES	NO	NO	NO	NO	NO	NO	YES	NO	NO	NO
	PX	Y	20-21	YES	YES	NO	NO	NO	NO	NO	NO	YES	NO	NO	NO
	GENERAL MARKET	M	20-21	YES	YES	NO	NO	NO	NO	NO	NO	YES	NO	NO	NO
KR-V8080	CHINA	C	20-21	YES	YES	NO	NO	NO	NO	NO	NO	YES	NO	NO	NO
	ENGLAND	T	32-70	YES	YES	NO	NO	NO	YES	YES	YES	NO	YES	YES	NO
	EUROPE	E	32-70	YES	YES	NO	NO	NO	YES	YES	YES	NO	YES	YES	NO
KR-V8080	U. S. A.	K	20-11	NO	NO	NO	NO	NO	NO	NO	NO	YES	NO	NO	NO
	CANADA	P	20-11	NO	NO	NO	NO	NO	NO	NO	NO	YES	NO	NO	NO

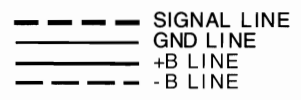

* New Parts
Parts without **Parts No.** are not supplied.
Les articles non mentionnés dans le **Parts No.** ne sont pas fournis.
Teile ohne **Parts No.** werden nicht geliefert.

Ref. No	Add-ress	New Parts	Parts No.	Description	Desti-nation	Re-marks
KR-V7080/V8080						
601	1A	*	A01-3269-01	METALLIC CABINET	KPY	7
602	1B	*	A09-0169-08	BATTERY COVER	XMC	7
604	2A	*	A60-0791-11	PANEL	TE	7
604	2A	*	A60-0792-11	PANEL		
604	2A	*	A60-0793-11	PANEL		
604	2A	*	A60-0794-11	PANEL	KPYXMC	8
605	1B	*	A70-1042-05	REMO-CON ASSY (RC-R0803)	TE	
605	1B	*	A70-1043-05	REMO-CON ASSY (RC-R0803)		
610	2A	*	B10-2170-02	FRONT GLASS	KPYXMC	
610	2A	*	B10-2253-02	FRONT GLASS	TE	
611	2A	*	B11-0294-02	COLOR FILTER		
612	2A	*	B43-0302-04	KENWOOD BADGE		
612	2A	*	B46-0092-43	WARRANTY CARD	KY	
-	-	-	B46-0096-53	WARRANTY CARD	X	
-	-	-	B46-0121-33	WARRANTY CARD	P	
-	-	-	B48-0197-00	QUESTIONNAIRE CARD	K	
-	-	-	B48-0310-03	WARRANTY CARD	TE	
-	-	-	B48-0326-03	WARRANTY CARD	C	
-	-	-	B58-0964-13	CAUTION CARD (CAUTION UL)	KY	
-	-	-	B58-0965-13	CAUTION CARD (TX TYPE PL)	XT	
-	-	-	B58-0966-13	CAUTION CARD (ELM TYPE PL)	EMC	
-	-	-	B58-0967-03	CAUTION CARD (P TYPE PL)	P	
-	-	-	B58-0968-04	CAUTION CARD	Y	
-	-	-	B59-1104-00	SERVICE DIRECTORY	Y	
-	-	-	B60-2486-00	I.MANUAL (KR-V7080/V8080 EN)	KPYXMC	
-	-	-	B60-2486-00	I.MANUAL (KR-V7080 EN)	T	
-	-	-	B60-2487-00	I.MANUAL (KR-V7080/V8080 FR)	P	
-	-	-	B60-2488-00	I.MANUAL (KR-V7080 FR/D)	E	
-	-	-	B60-2489-00	I.MANUAL (KR-V7080 IT/SP)	E	
-	-	-	B60-2490-00	I.MANUAL (KR-V7080 SP)	M	
-	-	-	B60-2491-00	I.MANUAL (KR-V7080 G)	M	
-	-	-	B60-2492-00	I.MANUAL (KR-V7080 C)	E	
-	-	-	B60-2493-00	I.MANUAL (KR-V7080 TAIWAN)	M	
615	1B	*	E03-0115-05	AC PLUG ADAPTER	M	
616	1C	*	E30-2592-15	AC POWER CORD	M	
616	1C	*	E30-2739-05	AC POWER CORD	M	
616	1C	*	E30-2787-05	AC POWER CORD	Y	
616	1C	*	E30-2788-05	AC POWER CORD	E	
616	1C	*	E30-2790-05	AC POWER CORD	X	
616	1C	*	E30-2791-05	AC POWER CORD	T	
616	1C	*	E30-2825-05	AC POWER CORD	C	
617	1C,2C	*	E35-1319-05	FLAT CABLE(27P/X09CN2-X14CN503)	T C	
621	1B	*	F20-1322-15	INSULATING BOARD	M	
622	1A	*	F20-1472-03	INSULATING BOARD		
-	-	-	H50-1736-04	ITEM CARTON CASE	KPYXE	8
-	-	-	H50-1749-04	ITEM CARTON CASE	M	7
-	-	-	H50-1750-04	ITEM CARTON CASE	T	7
-	-	-	H50-1751-04	ITEM CARTON CASE	C	7
-	-	-	H50-1752-04	ITEM CARTON CASE		
-	-	-	H10-7126-12	POLYSTYRENE FOAMED FIXTURE (L)	KPYXE	
-	-	-	H10-7126-12	POLYSTYRENE FOAMED FIXTURE (L)	MC	
-	-	-	H10-7127-12	POLYSTYRENE FOAMED FIXTURE (R)	KPYXE	

L : Scandinavia K : USA P : Canada C : China 7 : KR-V7080
 Y : PX(Far East, Hawaii) T : Europe E : Europe 8 : KR-V8080
 Y : AAFES(Europe) X : Australia M : Other Areas
 Δ indicates safety critical components.

* New Parts
Parts without **Parts No.** are not supplied.
Les articles non mentionnés dans le **Parts No.** ne sont pas fournis.
Teile ohne **Parts No.** werden nicht geliefert.

Ref. No	Add-ress	New Parts	Parts No.	Description	Desti-nation	Re-marks
-	-	-	H10-7127-12	POLYSTYRENE FOAMED FIXTURE (R)	MC	
-	-	-	H10-7128-12	POLYSTYRENE FOAMED FIXTURE (L)	T	
-	-	-	H10-7129-12	POLYSTYRENE FOAMED FIXTURE (R)	X	
-	-	-	H13-0223-04	CARTON BOARD	KPYXE	
-	-	-	H25-0232-04	PROTECTION BAG (235X350X0.03)	MC	
-	-	-	H25-0232-04	PROTECTION BAG (235X350X0.03)	T	
-	-	-	H25-0631-04	PROTECTION BAG (0232 PRINTED)		
-	-	-	H25-0661-04	PROTECTION BAG		
625	2B	*	J02-1148-13	FOOT (D=46, H=14.5)		
626	1C	*	J19-3385-05	UNIT HOLDER		
627	2C	*	J19-3731-04	UNIT HOLDER		
628	1A	*	J19-3645-05	LOOP ANTENNA STAND		
631	1C	*	J42-0083-05	POWER CORD BUSHING		
-	-	-	J19-2808-05	HOLDER	MC	
-	-	-	J61-0098-05	WIRE BAND		
-	-	-	J61-0307-05	WIRE BAND		
635	2A	*	K27-2176-04	KNOB (MAIN POWER)		
636	2A	*	K29-6246-12	KNOB	KPYXMC	
637	2A	*	K29-6247-04	KNOB (INPUT SELVOLUME)	TE	
638	2A	*	K29-6282-02	KNOB (REMOTE POWER)		
638	2A	*	K29-6284-02	KNOB (REMOTE POWER)		
T2	1A	*	L07-2059-05	POWER TRANSFORMER	KP	7
Δ T2	1A	*	L07-2060-05	POWER TRANSFORMER	Y	
Δ T2	1A	*	L07-2061-05	POWER TRANSFORMER	X	
Δ T2	1A	*	L07-2062-05	POWER TRANSFORMER	TE	
Δ T2	1A	*	L07-2063-05	POWER TRANSFORMER	KP	8
Δ T2	1A	*	L07-2142-05	POWER TRANSFORMER	C	
Δ T2	1A	*	L07-2146-05	POWER TRANSFORMER	M	
640	1A	*	T90-0195-05	LOOP ANTENNA		
641	1A	*	T90-0810-05	LEAD WIRE ANTENNA		
AUDIO UNIT (X09-434X-XX)						
C1,2			CC45FSL1H390J	CERAMIC	KPYXMC	
C3,4			CE04KW1H100M	ELECTRO		
C5,6			CC45FSL1H221J	CERAMIC	J 50WV	
C7,8			CE04KW1A101M	ELECTRO	J 10WV	
C9,10			CK45FBIH102K	CERAMIC	K	
C11,12			CQ93FMGIH123J	MYLAR	J	
C13,14			CQ93FMGIH392J	MYLAR	J	
C15,16			CE04KW1V4R7M	ELECTRO	35WV	
C17			CE04DW1V102M	ELECTRO	1000UF	
C18			CE04DW1V471M	ELECTRO	470UF	
C19,20			CK45FE2H103P	CERAMIC	P	
C21,22			C91-0749-05	CERAMIC	K	
C23,24			C91-0749-05	CERAMIC	K	
C25,26			C91-0749-05	CERAMIC	K	
C27,28			C91-0749-05	CERAMIC	K	
C29,30			C91-0749-05	CERAMIC	K	
C31,32			C91-0749-05	CERAMIC	K	
C33,36			CQ93FMGIH102J	MYLAR	K	
C38			CE04KW1J221M	ELECTRO	1000PF	
C39,40			CK45FBIH102K	CERAMIC	63WV	
C41,42			CE04KW1E470M	ELECTRO	1000PF	
					K 25WV	

L : Scandinavia K : USA P : Canada C : China 7 : KR-V7080
 Y : PX(Far East, Hawaii) T : Europe E : Europe 8 : KR-V8080
 Y : AAFES(Europe) X : Australia M : Other Areas
 Δ indicates safety critical components.

PARTS LIST

KR-V7080/V8080

PARTS LIST

4
* New Parts
Parts without **Parts No.** are not supplied.
Les articles non mentionnés dans le **Parts No.** ne sont pas fournis.
Teile ohne **Parts No.** werden nicht geliefert.

Ref. No	Add-ress	New Parts	Parts No.	Description	Desti-nation	Re-marks
C146			CC45FSL1H101J	CERAMIC		
C147,148			CC45FSL1H221J	CERAMIC	TE	
C149,150			CE04KW1A470M	ELECTRO		
C151,152			CC45FSL1H680J	CERAMIC		
C153			CE04KW2A010M	ELECTRO		
C155-158			CK45FB1H152K	CERAMIC		
C159,160			CC45FSL1H020C	CERAMIC		
C161,162			CC45FSL2H680J	CERAMIC		
C165-168			CK45FF1H103Z	CERAMIC		
C171,172			CQ93FMG1H104J	MYLAR		
C173			CE04KW0J221M	ELECTRO		
C174			CE04KW1V47R7M	ELECTRO		
C178,179			CQ93FMG1H822J	MYLAR		8
C178,179			CQ93FMG1H822J	MYLAR		7
C181			CK45FF1H103Z	CERAMIC		
C182			CE04KW1E101M	ELECTRO		
C184			CE04KW1A470M	ELECTRO		
C185			CE04KW1V47R7M	ELECTRO		
C186			CK45FF1H103Z	CERAMIC	KPTE	
C187-192			CQ93FMG1H102J	MYLAR		8
C195			CK45FB1H561K	CERAMIC		
C196,197			CK45FF1H103Z	CERAMIC	TE	
C201-204			CK45FB1H471K	CERAMIC		
C205			CQ93FMG1H471J	MYLAR		
C215,216			CQ93FMG1H102J	MYLAR		8
C221-224			C91-1480-05	MP		
C225,226			CC45FSL2H121J	CERAMIC		8
C225,226			CC45FSL2H470J	CERAMIC		7
C227			CC45FSL2H830J	CERAMIC		
C231,232			CQ93FMG1H102J	MYLAR		8
C233			CE04HW1E100M	NP-ELEC		
C238			CE04KW1H2R2M	ELECTRO		
C239-242			CQ93FMG1H104J	MYLAR		
C243,244			CQ93FMG1H562J	MYLAR		
C251,252			CE04KW1H2R2M	ELECTRO		
C253			CE04KW1C220M	ELECTRO		
C254			CE04KW1C101M	ELECTRO		
C255			CQ93FMG1H103J	MYLAR		8
C256-259			CQ93FMG1H101K	MYLAR		8
C261,262			CF92FV1H105J	MF-C		
C263,264			CQ93FMG1H101K	MYLAR		8
C271			CE04KW1C470M	ELECTRO		
C272			CQ93FMG1H102J	MYLAR		8
C343,344			CC45FSL1H221J	CERAMIC		
C345			CF92FV1H224J	MF-C		
C346			CF92FV1H684J	MF-C		
C347			CQ93FMG1H101K	MYLAR		8
C351,352			CE04KW1H2R2M	ELECTRO		
C353			CE04KW1H100M	ELECTRO		
C354			CE04KW1C470M	ELECTRO		
C355			CQ93FMG1H101K	MYLAR		8
C357			CQ93FMG1H103J	MYLAR		8
CN1			E40-4609-05	PIN ASSY (15P)		
CN2			E40-4914-05	FLAT CABLE CONNECTOR (27P)		

3
* New Parts
Parts without **Parts No.** are not supplied.
Les articles non mentionnés dans le **Parts No.** ne sont pas fournis.
Teile ohne **Parts No.** werden nicht geliefert.

Ref. No	Add-ress	New Parts	Parts No.	Description	Desti-nation	Re-marks
C43-45			CE04KW1C470M	ELECTRO		
C46			CE04KW1H100M	ELECTRO		7
C47,48			C90-3536-05	ELECTRO		8
C47,48			C90-3602-05	ELECTRO		8
C49		*	CQ93FMG1H102J	MYLAR		
C50			CE04HW1A220M	NP-ELEC		
C51			CE04KW1C220M	ELECTRO		
C52,53			CE04KW1C470M	ELECTRO		
C54-56			CK45FE2H103P	CERAMIC		
C57			CE04KW1C470M	ELECTRO		
C58			CK45FB1H102K	CERAMIC		
C59			CQ93FMG1H102J	MYLAR		8
C60			CE04KW1C470M	ELECTRO		
C61			CE04KW2A100M	ELECTRO		
C62			CE04KW2A101M	ELECTRO		
C63,64			CE04KW1H101M	ELECTRO		
C65			CE04KW1V47R7M	ELECTRO		
C66			CQ93FMG1H102J	MYLAR		8
C67,68			CE04KW1H2R2M	ELECTRO		
C69,70			CQ93FMG1H102J	MYLAR		8
C71,72			CK45FB1H102K	CERAMIC	TE	7
C71,72			CK45FB1H471K	CERAMIC	KPYXMC	7
C71,72			CQ93FMG1H471J	MYLAR		8
C73-76			CE04KW1C220M	ELECTRO		
C77			CK45FB1H471K	CERAMIC		
C78,79			CQ93FMG1H102J	MYLAR		8
C80,81			CK45FF1H103Z	CERAMIC		
C82,83			CC45FSL1H221J	CERAMIC		
C84			C91-0749-05	CERAMIC		
C86			CE04KW1H2R2M	ELECTRO		
C87,88			CK45FE2H103P	CERAMIC		8
C89,90			CE04KW1H101M	ELECTRO		
C91-94			CQ93FMG1H682J	MYLAR	TE	
C95,96			CK45FF1H103Z	CERAMIC	TE	
C98			CK45FB1H102K	CERAMIC	TE	
C101,102			CE04KW1H101M	ELECTRO		
C103,104			CQ93FMG1H102J	MYLAR		
C109,110			CE04KW1A101M	ELECTRO		
C111,112			CC45FSL1H101J	CERAMIC		
C113,114			CE04KW2A010M	ELECTRO		
C115,116			CK45FB1H471K	CERAMIC	TE	
C119,120			CC45FSL1H120J	CERAMIC	KPYXMC	
C119,120			CC45FSL1H180J	CERAMIC	TE	
C121,122			CC45FSL2H470J	CERAMIC	KPYXMC	
C121,122			CC45FSL2H680J	CERAMIC	TE	
C125-128			CK45FF1H103Z	CERAMIC		
C129			CQ93FMG1H123J	MYLAR		7
C129			CQ93FMG1H562J	MYLAR		8
C131,132			CQ93FMG1H104J	MYLAR		
C133,134			CQ93FMG1H183J	MYLAR		
C139			CQ93FMG1H123J	MYLAR		
C140			CK45FB1H102K	CERAMIC	TE	
C141,142			CE04KW1H101M	ELECTRO		
C143,144			CQ93FMG1H102J	MYLAR		
C145			CK45FB1H471K	CERAMIC		

L : Scandinavia K : USA P : Canada C : China 7 : KR-V7080
Y : PX(Far East, Hawaii) T : Europe E : Europe 8 : KR-V8080
V : AAFES(Europe) X : Australia M : Other Areas

L : Scandinavia K : USA P : Canada C : China 7 : KR-V7080
Y : PX(Far East, Hawaii) T : Europe E : Europe 8 : KR-V8080
V : AAFES(Europe) X : Australia M : Other Areas

Δ indicates safety critical components.

Δ indicates safety critical components.

KR-V7080/V8080

PARTS LIST

6

* New Parts
Parts without **Parts No.** are not supplied.
Les articles non mentionnés dans le **Parts No.** ne sont pas fournis.
Teile ohne **Parts No.** werden nicht geliefert.

Ref. No	Add-ress	New Parts	Parts No.	Description	Desti-nation	Re-marks
Δ R234	R374,375		R92-1769-05	CARBON		
Δ VR1_4			RD14NB2E820J	TRIMMING POT.(1K ADJUSTMENT)		
			R12-1616-05			
Δ K1-3			S76-0038-05	MAGNETIC RELAY (SP RELAY)		
Δ K1-3			S76-0045-05	MAGNETIC RELAY (SP RELAY)		
Δ K5		*	S76-0044-05	MAGNETIC RELAY		
Δ S1			S31-2136-05	SLIDE SWITCH (IMPEDANCE SEL)		
Δ S2			S31-2322-05	SLIDE SWITCH (120-/220-/240-)		YM
Δ S3			S62-0001-05	SLIDE SWITCH (120-/240-)		YM
Δ D1			RBV-602LFA	DIODE		
Δ D3-8			S6688B	DIODE		
Δ D9			1SR139-100	DIODE		
Δ D9			RD4.7ES(B2)	ZENER DIODE		
Δ D10			HSS104	DIODE		
Δ D10			1SS133	DIODE		
Δ D11			HZS6.2N(B2)	ZENER DIODE		
Δ D11			RD6.2ES(B2)	ZENER DIODE		
Δ D12			HZS8.2N(B2)	ZENER DIODE		
Δ D12			RD8.2ES(B2)	ZENER DIODE		
Δ D13_14			HZS16N(B2)	ZENER DIODE		
Δ D13_14			RD16ES(B2)	ZENER DIODE		
Δ D15_20			HSS104	DIODE		
Δ D15_20			1SS133	DIODE		
Δ D21_24			HSS104A	DIODE		
Δ D21_24			1SS131	DIODE		
Δ D25			HZS5.1N(B2)	ZENER DIODE		
Δ D25			RD5.1ES(B2)	ZENER DIODE		
Δ D29			HSS104A	DIODE		
Δ D29			1SS131	DIODE		
Δ D30			HZS5.1N(B2)	ZENER DIODE		
Δ D30			RD5.1ES(B2)	ZENER DIODE		
Δ D31_32			S6688B	DIODE		
Δ D31_32			1SR139-100	DIODE		
Δ D48			HSS104	DIODE		
Δ D48			1SS133	DIODE		
Δ D49			HSS104A	DIODE		
Δ D49			1SS131	DIODE		
Δ D50_53			S6688B	DIODE		
Δ D50_53			1SR139-100	DIODE		
Δ D54			HZS6.2N(B2)	ZENER DIODE		
Δ D54			RD6.2ES(B2)	ZENER DIODE		
Δ D55_56			HSS104A	DIODE		
Δ D55_56			1SS131	DIODE		
Δ D57			HZS2.7N(B2)	ZENER DIODE		
Δ D57			RD2.7ES(B2)	ZENER DIODE		
Δ D59			HSS104	DIODE		
Δ D59			1SS133	DIODE		
Δ D64			HSS104A	DIODE		
Δ D64			1SS131	DIODE		
Δ D71_72			HZS8.2N(B2)	ZENER DIODE		
Δ D71_72			RD8.2ES(B2)	ZENER DIODE		
Δ D73			HZS10N(B)	ZENER DIODE		

L : Scandinavia
Y : FX(Far East, Hawaii)
Y : AAFES(Europe)

K : USA
T : Europe
X : Australia

P : Canada
E : Europe
M : Other Areas

C : China

7 : KR-V7080
8 : KR-V8080

Δ indicates safety critical components.

5

* New Parts
Parts without **Parts No.** are not supplied.
Les articles non mentionnés dans le **Parts No.** ne sont pas fournis.
Teile ohne **Parts No.** werden nicht geliefert.

Ref. No	Add-ress	New Parts	Parts No.	Description	Desti-nation	Re-marks
Δ CN4			E40-4245-05	PIN ASSY (3P)		
Δ J1-3			E63-0139-15	PHONO JACK (6P)		
Δ J4			E63-0184-05	PHONO JACK (SUB WOOFER)		
Δ J6		*	E70-0065-05	LOCK TERMINAL BOARD (F/R SP)		
Δ J7			E70-0049-05	SCREW TERMINAL BOARD (F/C SP)		
Δ J8			E70-0064-05	AC OUTLET		
Δ J8			E03-0148-05	AC OUTLET		
Δ J8			E03-0149-05	AC OUTLET		
Δ J8			E03-0310-05	AC OUTLET		
Δ J8			E03-0325-05	AC OUTLET		
Δ J8			E03-0330-05	AC OUTLET		
Δ W212,213		*	E29-1614-03	LEAD PLATE		
Δ W214		*	E28-1615-04	LEAD PLATE		
Δ W215,216		*	E28-1616-04	LEAD PLATE		
Δ F1			F05-3121-05	FUSE (SEMKO)		
Δ F1			F50-0078-05	FUSE (5X20)		
Δ F2			F05-2525-05	FUSE (SEMKO)		
Δ F2			F05-3121-05	FUSE (SEMKO)		
Δ F3,4			F50-0078-05	FUSE (5X20)		
Δ F5,6			F04-1026-05	FUSE (UL)		
Δ F5,6			F06-1022-05	FUSE (SEMKO)		
Δ CN7_8			J13-0075-05	FUSE CLIP		
Δ CN10,11			J13-0075-05	FUSE CLIP		
Δ CN12-15			J13-0075-05	FUSE CLIP		
Δ CN16-19			J11-0809-05	WIRE CLAMP		
Δ J9			J11-0809-05	WIRE CLAMP		
Δ J10_11			J11-0809-05	WIRE CLAMP		
Δ T1			L07-0864-05	POWER TRANSFORMER		
Δ T1			L07-0865-05	POWER TRANSFORMER		
Δ T1			L07-0866-05	POWER TRANSFORMER		
Δ T1			L07-0867-05	POWER TRANSFORMER		
Δ T1			L07-2114-05	POWER TRANSFORMER		
Δ CP1_3			R90-0840-05	RD		
Δ CP4			R90-0166-05	MULTI-COMP		
Δ R27			RD14NB2E470J	0.47X2		
Δ R30			RS14KB3D822J	47		
Δ R41			RD14NB2E101J	8.2K		
Δ R42			RD14NB2E180J	100		
Δ R43_45			RD14NB2E331J	18		
Δ R49			RD14NB2E682J	330		
Δ R54			RD14NB2E3R3J	6.8K		
Δ R55			RD14NB2E470J	3.3		
Δ R99_100			RD14NB2E470J	47		
Δ R115-118			RD14NB2E221J	220		
Δ R123,124			RD14NB2E121J	120		
Δ R133-136			RD14NB2E220J	22		
Δ R137,138			RD14NB2E332J	3.3K		
Δ R143,144			RS14KB3D4R7J	4.7		
Δ R165-168			RD14NB2E221J	220		
Δ R173,174			RD14NB2E121J	120		
Δ R183-186			RD14NB2E220J	22		
Δ R187,188			RD14NB2E332J	3.3K		
Δ R193,194			RS14KB3D4R7J	4.7		

L : Scandinavia
Y : FX(Far East, Hawaii)
Y : AAFES(Europe)

K : USA
T : Europe
X : Australia

P : Canada
E : Europe
M : Other Areas

C : China

7 : KR-V7080
8 : KR-V8080

Δ indicates safety critical components.

KR-V7080/V8080

PARTS LIST

8 * New Parts
Parts without **Parts No.** are not supplied.
Les articles non mentionnés dans le **Parts No.** ne sont pas fournis.
Teile ohne **Parts No.** werden nicht geliefert.

Ref. No	Add-ress	New Parts	Parts No.	Description	Desti-nation	Re-marks
O105,106 C107,108 C109,110 C111,112		*	2SC4137F50(V,W) 2SD2389 2SB1559 2SC4137F50(V,W) 2SD2389 2SB1559	TRANSISTOR TRANSISTOR TRANSISTOR TRANSISTOR		
DISPLAY UNIT (X14-4120-XX/X14-4132-XX)						
D17-19			B30-2461-05	LED(RED,5 1/4)		
C1			C90-3253-05	ELECTRO		50WV
C2			CE04KW1H010M	ELECTRO		50WV
C3			C90-1827-05	ELECTRO		5.5WV
C4			CE04KW1A221M	ELECTRO		10WV
C5,6			C90-3242-05	ELECTRO		35WV
C7			CE04KW1C330M	ELECTRO		16WV
C8-10			C91-0769-05	CERAMIC		0.010UF
C11			CC73FCH1H470J	CHIP C		47PF
C12			CE04KW1H2R2M	ELECTRO		2.2UF
C13			CC45FSL1H331J	CERAMIC		330PF
C14			CK73FB1H103K	CHIP C		0.010UF
C15			CC73FCH1H220J	CHIP C		22PF
C16			CC45FSL1H561J	CERAMIC		560PF
C17			CE04KW1C100M	ELECTRO		10UF
C18			CK73FB1H103K	CHIP C		0.010UF
C19			CE04KW1C100M	ELECTRO		10UF
C20			CK73FB1H102K	CHIP C		1000PF
C21			C91-1488-05	MF		6800PF
C22,23 C24			CK45FF1H103Z CK73FB1E473K	CERAMIC CHIP C		0.010UF 0.047UF
C101-104 C105 C131,132 C133 C200			CO93FMG1H103J CK73FB1H102K CK45FB1H561K CK45FF1H223Z CK45FF1H473Z	MYLAR CHIP C CERAMIC CERAMIC CERAMIC		0.010UF 1000PF 560PF 0.022UF 0.047UF
C301,302 C303 C304 C304 C305			CK73FB1H103K CE04KW1C100M CE04KW1A470M CK73FB1E473K CE04KW1C100M	CHIP C ELECTRO ELECTRO CHIP C ELECTRO		0.010UF 10UF 47UF 0.047UF 10UF
C305 C306 C307 C308 C308			CK73FB1H103K CK73FB1E473K CE04KW1C100M CE04KW1H010M CK73FB1H103K	CHIP C CHIP C CHIP C ELECTRO CHIP C		0.010UF 0.047UF 10UF 10UF 0.010UF
C309 C310 C311 C311			CE04KW1HR47M CE04KW1H2R2M CK73FB1H102K CE04KW1HR47M CE04KW1V4R7M	ELECTRO ELECTRO CHIP C ELECTRO ELECTRO		0.47UF 2.2UF 1000PF 0.47UF 4.7UF
C312 C313 C314 C314			CK73FB1E473K CC73FCH1H220J CE04KW1H010M CE04KW1A101M CE04KW1H2R2M	CHIP C CHIP C ELECTRO ELECTRO ELECTRO		0.047UF 22PF 10UF 100UF 2.2UF
C315 C316 C317,318			CK73FB1H472K CE04KW1H010M CE04KW1C100M	CHIP C ELECTRO ELECTRO		4700PF 1.0UF 10UF

7 * New Parts
Parts without **Parts No.** are not supplied.
Les articles non mentionnés dans le **Parts No.** ne sont pas fournis.
Teile ohne **Parts No.** werden nicht geliefert.

Ref. No	Add-ress	New Parts	Parts No.	Description	Desti-nation	Re-marks
D73 D75,76 D77,78 D77,78			RD10ES(B) HZS6.2N(B2) FD8.2ES(B2) S5688B 1SR139-100	ZENER DIODE ZENER DIODE ZENER DIODE DIODE DIODE		
D79 D79 D80 D80 D90			HSS104 1SS133 HZS5.1N(B2) RD5.1ES(B2) HSS104	DIODE DIODE ZENER DIODE ZENER DIODE DIODE		
D90 IC1 IC2 IC3 IC4			1SS133 NJM4580L-D NJM4565L-D NJM4580D-D NJU7312AL	DIODE IC(OP AMP X2) ANALOGUE IC IC(OP AMP X2) ANALOGUE IC		
IC5 IC6 IC7 Q2 Q3			NJU7311AL TDA7315 TDA7345D 2SC2878(B) 2SD2012	ANALOGUE IC ANALOGUE IC ANALOGUE IC TRANSISTOR TRANSISTOR		
Q3 Q5 Q6 Q6			2SD2061(E,F) 2SC2458(Y,GR) 2SC3311A(Q,R) 2SB1370(E,F) 2SB1375	TRANSISTOR TRANSISTOR TRANSISTOR TRANSISTOR TRANSISTOR		
Q7 Q7 Q8 Q8 Q9 Q9			2SC2458(Y,GR) 2SC3311A(Q,R) 2SA1048(Y,GR) 2SA1309A(Q,R) 2SA1534A(R,S)	TRANSISTOR TRANSISTOR TRANSISTOR TRANSISTOR TRANSISTOR		
Q10-12 Q10-12 Q14 Q14 Q15-18			DTC113ZS UN4219 2SA1048(Y,GR) 2SA1309A(Q,R) 2SC2878(B)	DIGITAL TRANSISTOR TRANSISTOR TRANSISTOR TRANSISTOR TRANSISTOR		
Q19 Q19 Q20 Q20 Q21-24			DTC124ES UN4212 2SC2458(Y,GR) 2SC3311A(Q,R) 2SA992(F,E)	DIGITAL TRANSISTOR TRANSISTOR TRANSISTOR TRANSISTOR TRANSISTOR		
Q25-28 Q29-30 Q31,32 Q33-36 Q37-40			2SC2631(R,S) 2SA1123(R,S) 2SA1845(F,E) 2SC1845(F,E) 2SA992(F,E) 2SC2631(R,S)	TRANSISTOR TRANSISTOR TRANSISTOR TRANSISTOR TRANSISTOR TRANSISTOR		
Q41,42 Q43-46 Q47,48 Q49,50 Q63			2SA1123(R,S) 2SC1845(F,E) 2SA992(F,E) 2SC2878(B) 2SC2003(L,K)	TRANSISTOR TRANSISTOR TRANSISTOR TRANSISTOR TRANSISTOR		
Q64 Q90 Q90			2SC3940A(R,S) DTC124ES UN4212	TRANSISTOR DIGITAL TRANSISTOR TRANSISTOR		
Q101,102 Q103,104			2SD2222 #5 2SB1470 #5	TRANSISTOR TRANSISTOR		

L: Scandinavia
Y: PX(Far East, Hawaii)
Y: AAFES(Europe)

K: USA
T: Europe
X: Australia

P: Canada
E: Europe
M: Other Areas

C: China

7: KR-V7080
8: KR-V8080

Δ indicates safety critical components.

KR-V7080/V8080

PARTS LIST

* New Parts
Parts without **Parts No.** are not supplied.
Les articles non mentionnés dans le **Parts No.** ne sont pas fournis.
Teile ohne **Parts No.** werden nicht geliefert.

Ref. No	Add-ress	New Parts	Parts No.	Description	Desti-nation	Re-marks
C363			CK73FB1H103K	CHIP C	TE	
C364			CE04KW1H010M	ELECTRO	TE	
C365			CE04KW1H010M	ELECTRO	KPYXMC	
C365			CK73FB1E473K	CHIP C	TE	
C366			CK73FB1H102K	CHIP C	KPYXMC	
C371			CE04KW1C100M	ELECTRO	KPYXMC	
C372			CE04KW1C470M	ELECTRO	KPYXMC	
C403-406			CE04KW1HR47M	ELECTRO	KPYXMC	
C407			CK73FB1E473K	CHIP C	KPYXMC	
C412			CC73FSL1H101J	CHIP C	KPYXMC	
C414			CK73FB1H681K	CHIP C	KPYXMC	
C415,416			CK73FSL1H101J	CHIP C	KPYXMC	
C421,422			CE04KW1C470M	ELECTRO	KPYXMC	
C423			CK73FB1H682J	CHIP C	YMC	
C438			CQ93FMG1H682J	MYLAR	YMC	
C482			CC73FSL1H150J	CHIP C	KPYXMC	
C501			CQ93FMG1H223J	MYLAR	KPYXMC	
C502			CQ93FMG1H473J	MYLAR	KPYXMC	
C503			CE04KW1A221M	ELECTRO	KPYXMC	
C504-507			CE04KW1C100M	ELECTRO	YMC	
C508			CE04KW1A221M	ELECTRO	KPYXMC	
C509,510			CQ93FMG1H104J	MYLAR	J	
C511			CE04KW1HR47M	ELECTRO	J	
C512			CE04KW1V4F7M	ELECTRO	50WV	
C513			CE04KW1HR47M	ELECTRO	35WV	
C514			CE04KW1V4F7M	ELECTRO	50WV	
C515			CF92FV1H154J	MF-C	35WV	
C516			CE04KW1HR33M	ELECTRO	J	
C517,518			CF92FV1H154J	MF-C	50WV	
C519			CE04KW1HR33M	ELECTRO	J	
C520			CF92FV1H154J	MF-C	50WV	
C521			CE04KW1V4F7M	ELECTRO	J	
C522			CE04KW1HR47M	ELECTRO	35WV	
C523			CE04KW1V4F7M	ELECTRO	35WV	
C524			CE04KW1HR47M	ELECTRO	50WV	
C525,526			CQ93FMG1H104J	MYLAR	J	
C527			CE04KW1C470M	ELECTRO	16WV	
C528,529			CF92FV1H474J	MF-C	J	
C530,531			CE04KW1C100M	ELECTRO	16WV	
C532			CQ93FMG1H681J	MYLAR	J	
C533-535			CE04KW1H010M	ELECTRO	50WV	
C536			CE04KW1C100M	ELECTRO	16WV	
C537			CK73FB1H103K	CHIP C	K	
C538			CE04KW1H2R2M	ELECTRO	50WV	
C539			CE04KW1C100M	ELECTRO	16WV	
C540			CE04KW1HR33M	ELECTRO	50WV	
C541			CE04KW1C100M	ELECTRO	16WV	
C542			CE04KW1A221M	ELECTRO	10WV	
C543,544			CE04KW1C100M	ELECTRO	16WV	
C545			CE04KW1HR47M	ELECTRO	50WV	
C546			CQ93FMG1H823J	MYLAR	J	
C547			CQ93FMG1H832J	MYLAR	J	
C548			CQ93FMG1H823J	MYLAR	J	
C549			CE04KW1A221M	ELECTRO	10WV	
C550			CK73FB1H102K	CHIP C	K	

* New Parts
Parts without **Parts No.** are not supplied.
Les articles non mentionnés dans le **Parts No.** ne sont pas fournis.
Teile ohne **Parts No.** werden nicht geliefert.

Ref. No	Add-ress	New Parts	Parts No.	Description	Desti-nation	Re-marks
C319,320			CQ93FMG1H273J	MYLAR	TE	
C321			CK73FB1H103K	CHIP C	TE	
C321			CQ93FMG1H163J	MYLAR	YXMC	
C321			CQ93FMG1H243J	MYLAR	KP	
C322			CC73FSL1H101J	CHIP C	TE	
C322			CQ93FMG1H163J	MYLAR	YXMC	
C322			CQ93FMG1H243J	MYLAR	KP	
C323			CE04KW1H010M	ELECTRO	KPYXMC	
C323			CE04KW1H2R2M	ELECTRO	TE	
C324			CE04KW1H2R2M	ELECTRO	TE	
C324			CE04KW1H3R3M	ELECTRO	KPYXMC	
C325			CE04KW1C100M	ELECTRO	KPYXMC	
C325			CK73FB1H562K	CHIP C	TE	
C326			CK73FB1H562K	CHIP C	TE	
C327			CK73FB1E473K	CHIP C	TE	
C328			CC73FSL1H150J	CHIP C	TE	
C328			CE04KW1C100M	ELECTRO	KPYXMC	
C329			CE04KW1H0R1M	ELECTRO	TE	
C330			CE04KW1C470M	ELECTRO	TE	
C331			CE04KW1A470M	ELECTRO	KPYXMC	
C331			CK73FB1E473K	CHIP C	TE	
C332			CK73FB1H103K	CHIP C	K	
C333			CK73FB1H270J	CHIP C	J	
C334			CK73FB1H220J	CHIP C	J	
C335,336			CC73FSL1H101J	CHIP C	J	
C335,336			CK73FB1H471K	CHIP C	K	
C336			CK73FSL1H101J	CHIP C	KPYXMC	
C338			CK73FB1H471K	CHIP C	TE	
C339			CE04KW1C470M	ELECTRO	KPYXMC	
C340			CK73FB1H223K	CHIP C	KPYXMC	
C340			CQ93FMG1H223J	MYLAR	TE	
C341			CE04KW1H2R2M	NP-ELEC	TE	
C342			CE04KW1H010M	ELECTRO	KPYXMC	
C342,343			CK73FB1H103K	CHIP C	TE	
C344			CE04KW1A470M	ELECTRO	TE	
C345			CE04KW1C470M	ELECTRO	TE	
C346			CE04KW1H010M	ELECTRO	TE	
C347			CK73FB1H103K	CHIP C	TE	
C348			CE04KW1H010M	ELECTRO	TE	
C349			CK73FB1H103K	CHIP C	TE	
C350			CC73FCH1H330J	CHIP C	TE	
C350			C91-0769-05	CERAMIC	KPYXMC	
C351			CE04KW1H010M	ELECTRO	KPYXMC	
C351			CK73FB1H102K	CHIP C	TE	
C352			CE04KW1C470M	ELECTRO	KPYXMC	
C352			CK73FB1H102K	CHIP C	TE	
C353,354			CK73FB1H102K	CHIP C	TE	
C355			CK73FB1H222K	CHIP C	TE	
C356			CC73FCH1H060D	CHIP C	TE	
C357			CC73FCH1H220J	CHIP C	TE	
C358			CK73FB1E473K	CHIP C	TE	
C359			CK73FB1H102K	CHIP C	TE	
C360			CC73FSL1H101J	CHIP C	TE	
C361			C91-0745-05	CERAMIC	TE	
C362			CC45FSL1H020C	CERAMIC	TE	

L : Scandinavia K : USA P : Canada C : China
 Y : PX(Far East, Hawaii) T : Europe E : Europe
 X : Australia M : Other Areas
 7 : KR-V7080
 8 : KR-V8080
 ▲ indicates safety critical components.

KR-V7080/V8080

PARTS LIST

* New Parts
Parts without **Parts No.** are not supplied.
Les articles non mentionnés dans le **Parts No.** ne sont pas fournis.
Teile ohne **Parts No.** werden nicht geliefert.

Ref. No	Add-ress	New Parts	Parts No.	Description	Desti-nation	Re-marks
X301			L77-2159-05	CRYSTAL RESONATOR(7.3MHZ)		
X302			L78-0637-05	RESONATOR (456KHZ)		
X301		*	L78-0290-03	RESONATOR (30MHZ)		
CP1			R90-0492-05	MULTI-COMP		
R1			RK73FB2B101J	CHIP R		1/6W
R8-5			RK73FB2A101J	CHIP R		1/8W
R6			RK73FB2A102J	CHIP R		1/10W
R8			RK73FB2A104J	CHIP R		1/10W
R9			RK73FB2A102J	CHIP R		1/10W
R10,11			RK73FB2A103J	CHIP R		1/10W
R15,16			RK73FB2A31J	CHIP R		1/10W
R17,18			RK73FB2A104J	CHIP R		1/10W
R19,20			RD14NB2E221J	RD		1/4W
R22			RD14NB2E100J	RD		1/4W
R23-27			RK73FB2A102J	CHIP R		1/10W
R28-30			RK73FB2A103J	CHIP R		1/10W
R38,39			RK73FB2A472J	CHIP R		1/10W
R44,45			RK73FB2A103J	CHIP R		1/10W
R52			RK73EB2B103J	CHIP R		1/8W
R54			RK73FB2A222J	CHIP R		2.2K
R69-72			RK73FB2A101J	CHIP R		1/10W
R75-77			RK73FB2A101J	CHIP R		1/10W
R80			RK73FB2A222J	CHIP R		2.2K
R82,83			RK73FB2A223J	CHIP R		2.2K
R111,112			RK73FB2A683J	CHIP R		1/10W
R113,114			RK73EB2B683J	CHIP R		1/8W
R115-120			RK73FB2A683J	CHIP R		1/10W
R121			RK73EB2B683J	CHIP R		1/8W
R122-125			RK73FB2A683J	CHIP R		1/10W
R131,132			RS14KB3D561J	FL-PROOF RS		2W
R301			RK73FB2A681J	CHIP R		1/10W
R302			RK73FB2A332J	CHIP R		1/10W
R303			RK73FB2A331J	CHIP R		1/10W
R304			RK73FB2A392J	CHIP R		1/10W
R305			RK73FB2A470J	CHIP R		1/10W
R306			RK73FB2A101J	CHIP R		1/10W
R307			RK73FB2A331J	CHIP R		1/10W
R308			RK73FB2A332J	CHIP R		1/10W
R309			RK73FB2A222J	CHIP R		3.3K
R310			RK73FB2A473J	CHIP R		4.7K
R311			RK73FB2A562J	CHIP R		5.6K
R312			RS14KB3A620J	FL-PROOF RS		82
R313			RK73FB2A302J	CHIP R		1/10W
R314			RK73FB2A393J	CHIP R		3.9K
R315			RK73FB2A472J	CHIP R		4.7K
R316			RK73FB2A391J	CHIP R		1/10W
R317			RK73FB2A473J	CHIP R		4.7K
R318			RK73FB2A104J	CHIP R		1/10W
R319			RK73FB2A392J	CHIP R		3.9K
R320			RK73FB2A333J	CHIP R		1/10W
			RK73FB2A223J	CHIP R		2.2K
			RK73FB2A332J	CHIP R		3.3K
			RK73FB2A222J	CHIP R		2.2K

* New Parts
Parts without **Parts No.** are not supplied.
Les articles non mentionnés dans le **Parts No.** ne sont pas fournis.
Teile ohne **Parts No.** werden nicht geliefert.

Ref. No	Add-ress	New Parts	Parts No.	Description	Desti-nation	Re-marks
C551			CE04KW1C100M	ELECTRO		
C552			CK73FB1H103K	CHIP C		
C553,554			CE04KW1C100M	ELECTRO		
C555			CO93FMG1H222J	MYLAR		
C556			CO93FMG1H103J	MYLAR		
C557,558			CF92EV1H101K	MF-C		
C561			CK73FSL1H101J	CHIP C		16WV
C601-572			CE04KW1C470M	ELECTRO		K
C602			CE04KW1C101M	ELECTRO		16WV
C604			CK73FB1H103K	CHIP C		16WV
C605			CK73FB1E104K	CHIP C		K
C606			CE04KW1H010M	ELECTRO		50WV
C703,704			CC73FSL1H470J	CHIP C		1.0UF
C705-707			CE04KW1C100M	ELECTRO		47PF
C708			CK73FB1H103K	CHIP C		10UF
C709			CE04KW1A221M	ELECTRO		0.010UF
C710			CK73FB1H103K	CHIP C		10WV
C711,712			CK73FSL1H221J	CHIP C		0.010UF
C713			CK73FB1H103K	CHIP C		K
CN501			E40-4609-05	PIN ASSY (15P)		
CN502			E40-4294-05	FLAT CABLE CONNECTOR (4P)		
CN503			E40-4914-05	FLAT CABLE CONNECTOR (27P)		
J1			E11-0272-05	PHONE JACK (PHONES)		
J301			E70-0052-05	LOCK TERMINAL BOARD		
J701			E63-0138-15	PHONO JACK(4P VIDEO)		
J702			E11-0188-05	MINIATURE PHONE JACK(2P S.CON)		
E102			J11-0809-05	WIRE CLAMPER		
E103-106			J11-0808-05	WIRE CLAMPER		
CF301,302			L72-0531-05	CERAMIC FILTER		KPYXMC
CF301,302			L72-0536-05	CERAMIC FILTER		TE
CF303			L72-0574-05	CERAMIC FILTER		KPYXMC
L1,2			L40-1001-17	SMALL FIXED INDUCTOR(10UH,K)		TE
L3			L40-1091-17	SMALL FIXED INDUCTOR(1UH)		TE
L4			L40-1091-17	SMALL FIXED INDUCTOR(1UH)		YMC
L301,302			L79-1219-05	LC FILTER		TE
L303			L30-0910-05	FM IFT		TE
L305			L79-0125-05	LC FILTER		TE
L306			L39-1328-05	COMBINATION COIL		TE
L306			L39-1337-05	COMBINATION COIL		TE
L307			L30-0467-05	AM IFT		TE
L308,309			L40-1091-17	SMALL FIXED INDUCTOR(1UH)		TE
L310			L40-1091-17	SMALL FIXED INDUCTOR(1UH)		KPYXMC
L311			L40-1001-17	SMALL FIXED INDUCTOR(10UH,K)		TE
L311			L40-1021-14	SMALL FIXED INDUCTOR(1.0MH,K)		KPYXMC
L312			L40-1091-17	SMALL FIXED INDUCTOR(1UH)		KPYXMC
L403			L39-1328-05	COMBINATION COIL		KPYXMC
L403			L39-1337-05	COMBINATION COIL		KPYXMC
L406			L40-1091-17	SMALL FIXED INDUCTOR(1UH)		KPYXMC
L601			L40-1001-17	SMALL FIXED INDUCTOR(10UH,K)		TE
L602			L40-1091-17	SMALL FIXED INDUCTOR(1UH)		TE
X1			L78-0267-05	RESONATOR (4.194MHZ)		TE
X2			L78-0244-05	RESONATOR (4.000M)		TE
X3			L77-2002-05	CRYSTAL RESONATOR(4.332MHZ)		TE

L : Scandinavia
Y : PX(Far East, Hawaii)
Y : AAF(E)(Europe)

K : USA
T : Europe
X : Australia

P : Canada
E : Europe
M : Other Areas

C : China

7 : KR-V7080
8 : KR-V8080

△ indicates safety critical components.

L : Scandinavia
Y : PX(Far East, Hawaii)
Y : AAF(E)(Europe)

K : USA
T : Europe
X : Australia

P : Canada
E : Europe
M : Other Areas

C : China

7 : KR-V7080
8 : KR-V8080

△ indicates safety critical components.

KR-V7080/V8080

14

* New Parts
Parts without **Parts No.** are not supplied.
Les articles non mentionnés dans le **Parts No.** ne sont pas fournis.
Teile ohne **Parts No.** werden nicht geliefert.

Ref. No	Add-ress	New Parts	Parts No.	Description	Re-marks
R381			RK73FB2A563J	CHIP R	TE
R384			RK73FB2A101J	CHIP R	TE
R401,402			RK73FB2A393J	CHIP R	KPYXMC
R405,406			RK73FB2A123J	CHIP R	KPYXMC
R411			RD14NB2E470J	RD	KPYXMC
R418			RK73FB2A122J	CHIP R	KPYXMC
R419			RK73FB2A123J	CHIP R	KPYXMC
R422			RK73FB2A123J	CHIP R	KPYXMC
R423			RK73FB2A123J	CHIP R	KPYXMC
R424			RK73FB2A103J	CHIP R	KPYXMC
R425,426			RK73FB2A393J	CHIP R	KPYXMC
R427,428			RD14NB2E101J	RD	KPYXMC
R431,432			RK73FB2A393J	CHIP R	KPYXMC
R438,439			RK73FB2A561J	CHIP R	KPYXMC
R440,441			RK73FB2A473J	CHIP R	YMC
R451			RK73FB2A821J	CHIP R	KPYXMC
R452			RK73FB2A473J	CHIP R	KPYXMC
R453			RK73FB2A472J	CHIP R	KPYXMC
R457			RK73FB2A102J	CHIP R	KPYXMC
R467			RK73FB2A104J	CHIP R	KPYXMC
R501,502			RK73FB2A103J	CHIP R	KPYXMC
R503,504			RK73FB2A102J	CHIP R	KPYXMC
R509			RK73FB2A473J	CHIP R	KPYXMC
R510			RK73FB2A102J	CHIP R	KPYXMC
R511			RK73FB2A222J	CHIP R	KPYXMC
R512			RK73FB2A473J	CHIP R	KPYXMC
R513			RK73FB2A100J	CHIP R	KPYXMC
R514			RK73FB2A223J	CHIP R	KPYXMC
R518			RK73FB2A393J	CHIP R	KPYXMC
R519			RK73FB2A105J	CHIP R	KPYXMC
R521			RK73FB2A473J	CHIP R	KPYXMC
R522			RK73FB2A102J	CHIP R	KPYXMC
R523			RK73FB2A222J	CHIP R	KPYXMC
R524			RK73FB2A473J	CHIP R	KPYXMC
R525			RK73FB2A100J	CHIP R	KPYXMC
R526,527			RK73FB2A104J	CHIP R	KPYXMC
R528			RK73FB2A223J	CHIP R	KPYXMC
R531,532			RK73FB2A104J	CHIP R	KPYXMC
R557			RK73FB2A223J	CHIP R	KPYXMC
R601			RK73FB2A102J	CHIP R	KPYXMC
R602			RK73FB2A222J	CHIP R	KPYXMC
R603			RK73FB2A393J	CHIP R	KPYXMC
R604			RK73FB2A103J	CHIP R	KPYXMC
R606			RK73FB2A102J	CHIP R	KPYXMC
R607			RS14KB3D270J	FL-PROOF RS	KPYXMC
R701,704			RK73FB2A750J	CHIP R	TE
R705,706			RK73FB2A332J	CHIP R	TE
R707,708			RS14KB3A391J	FL-PROOF RS	TE
W201			R92-0670-05	CHIP R	TE
W900			R92-0679-05	CHIP R	TE
W401			R92-0670-05	CHIP R	TE
W406			R92-0670-05	CHIP R	TE
W408-411			R92-0670-05	CHIP R	TE
W414-416			R92-0670-05	CHIP R	TE
W418,419			R92-0670-05	CHIP R	TE

13

* New Parts
Parts without **Parts No.** are not supplied.
Les articles non mentionnés dans le **Parts No.** ne sont pas fournis.
Teile ohne **Parts No.** werden nicht geliefert.

Ref. No	Add-ress	New Parts	Parts No.	Description	Re-marks
R321,322			RK73FB2A122J	CHIP R	TE
R321,322			RK73FB2A393J	CHIP R	KPYXMC
R323			RK73FB2A472J	CHIP R	TE
R324			RK73FB2A102J	CHIP R	KPYXMC
R324			RK73FB2A472J	CHIP R	TE
R325			RK73FB2A103J	CHIP R	KPYXMC
R325			RK73FB2A561J	CHIP R	TE
R326			RK73FB2A472J	CHIP R	TE
R327			RK73FB2A473J	CHIP R	TE
R328			RK73FB2A821J	CHIP R	TE
R329,330			RK73FB2A102J	CHIP R	TE
R331			RK73FB2A822J	CHIP R	TE
R331			RS14KB3D221J	FL-PROOF RS	KPYXMC
R332,333			RK73FB2A102J	CHIP R	KPYXMC
R332,333			RK73FB2A472J	CHIP R	TE
R334			RK73FB2A104J	CHIP R	KPYXMC
R335			RK73FB2A102J	CHIP R	TE
R335			RK73FB2A472J	CHIP R	TE
R336,337			RK73FB2A102J	CHIP R	TE
R338			RK73FB2A102J	CHIP R	TE
R338			RK73FB2A221J	CHIP R	KPYXMC
R339			RK73FB2A822J	CHIP R	KPYXMC
R340			RK73FB2A102J	CHIP R	KPYXMC
R340			RK73FB2A471J	CHIP R	TE
R341			RK73FB2A821J	CHIP R	TE
R342			RD14NB2E101J	RD	TE
R343			RK73FB2A103J	CHIP R	TE
R344			RK73FB2B221J	CHIP R	TE
R345			RK73FB2A122J	CHIP R	TE
R346			RK73FB2A750J	CHIP R	TE
R347			RK73FB2A681J	CHIP R	TE
R348			RK73FB2A621J	CHIP R	TE
R349			RK73FB2A104J	CHIP R	TE
R350			RK73FB2A71J	CHIP R	TE
R351			RK73FB2A181J	CHIP R	TE
R352			RK73FB2A104J	CHIP R	TE
R352			RK73FB2A472J	CHIP R	KPYXMC
R353			RK73FB2A103J	CHIP R	TE
R354,355			RK73FB2A223J	CHIP R	TE
R356			RK73FB2A104J	CHIP R	TE
R357			RK73FB2A473J	CHIP R	TE
R358			RK73FB2A104J	CHIP R	TE
R361			RK73FB2A122J	CHIP R	TE
R362			RK73FB2A123J	CHIP R	TE
R363			RK73FB2A122J	CHIP R	TE
R364			RK73FB2A104J	CHIP R	KPYXMC
R364			RK73FB2A123J	CHIP R	TE
R365			RK73FB2A683J	CHIP R	TE
R366			RK73FB2A473J	CHIP R	TE
R367			RK73FB2A104J	CHIP R	TE
R369			RK73FB2A102J	CHIP R	TE
R370			RK73FB2A104J	CHIP R	TE
R371			RK73FB2A102J	CHIP R	TE
R378			RD14NB2E470J	RD	TE
R379			RS14KB3D221J	FL-PROOF RS	TE

L : Scandinavia
K : USA
P : Canada
Y : PxFar East, Hawaii
T : Europe
V : AAFES(Europe)
C : China
7 : KR-V7080
8 : KR-V8080
X : Australia
M : Other Areas

Δ indicates safety critical components.

KR-V7080/V8080

PARTS LIST

* New Parts
Parts without **Parts No.** are not supplied.
Les articles non mentionnés dans le **Parts No.** ne sont pas fournis.
Teile ohne **Parts No.** werden nicht geliefert.

16

Ref. No	Add-ress	New Parts	Parts No.	Description	Desti-nation	Re-marks
D308			1SS268	DIODE	TE	
D309			MA111	DIODE	TE	
D310			MA111	ZENER DIODE	KPYXMC	
D311			HZS6.2N(B2)	ZENER DIODE	KPYXMC	
			RD8.2ES(B2)	ZENER DIODE	KPYXMC	
D411.412			MA111	DIODE	KPYXMC	
D601.602			MA111	DIODE	KPYXMC	
D603			HZS10N(B)	ZENER DIODE	KPYXMC	
D603			RD10ES(B)	ZENER DIODE	KPYXMC	
D703.704			HZS5.1N(B2)	ZENER DIODE	KPYXMC	
D703.704			RD5.1ES(B2)	ZENER DIODE	KPYXMC	
D705.706			HSS104	DIODE	KPYXMC	
D705.706			1SS133	DIODE	KPYXMC	
ED1		*	1-1MT-32GK	INDICATOR TUBE		
IC1		*	UPD78044AGF160	MI-COM IC	KPYXMC	
IC1		*	UPD78045AGF027	MI-COM IC	TE	
IC2			S-806D-Z	ANALOGUE IC	TE	
IC3			SAA6579	ANALOGUE IC	TE	
IC4			LC6543H-4D68	MI-COM IC	KPYXMC	
IC301			LA1831A-KEN	ANALOGUE IC	TE	
IC301			LA1836	ANALOGUE IC	TE	
IC302			LC7218	IC/PLL FREQUENCY SYNTHESIZER)	TE	
IC303			M5223P	IC(OP AMP X2)	TE	
IC312			NUM4565D	IC(OP AMP X2)	TE	
IC501		*	LA2786	ANALOGUE IC	KPYXMC	
IC502		*	LV1015	DI BI-POLAR IC	TE	
IC503			NUM4565-LD	ANALOGUE IC	TE	
IC701			NUM2279D	IC(VIDEO IC)	TE	
Q1			2SC4081(R,S)	TRANSISTOR	YMC	
Q1			2SC4116(Y,GR)	TRANSISTOR	YMC	
Q2			2SC2458(Y,GR)	TRANSISTOR	KPYXMC	
Q2			2SC3311(A,Q,R)	TRANSISTOR	KPYXMC	
Q3			2SA1048(Y,GR)	TRANSISTOR	KPYXMC	
Q3			2SA1309(A,Q,R)	TRANSISTOR	KPYXMC	
Q301			2SC2714(R,O)	TRANSISTOR	TE	
Q302			2SC1845(E,E)	TRANSISTOR	TE	
Q303			2SC2458(Y,GR)	TRANSISTOR	TE	
Q303			2SC3311(A,Q,R)	TRANSISTOR	TE	
Q303			2SC4081(R,S)	TRANSISTOR	TE	
Q303			2SC4116(Y,GR)	TRANSISTOR	TE	
Q304.305			2SC4081(R,S)	TRANSISTOR	TE	
Q304.305			2SC4116(Y,GR)	TRANSISTOR	TE	
Q307		*	2SA1576A(R,S)	TRANSISTOR	TE	
Q307			2SA1586(Y,GR)	TRANSISTOR	TE	
Q307			2SC4081(R,S)	TRANSISTOR	TE	
Q307			2SC4116(Y,GR)	TRANSISTOR	TE	
Q308		*	2SA1576A(R,S)	TRANSISTOR	TE	
Q308			2SA1586(Y,GR)	TRANSISTOR	TE	
Q309			2SC3940A(R,S)	TRANSISTOR	TE	
Q309			2SD863(E,F)	TRANSISTOR	TE	
Q310		*	2SA1576A(R,S)	TRANSISTOR	TE	
Q310			2SA1586(Y,GR)	TRANSISTOR	TE	
Q311			2SC3940A(R,S)	TRANSISTOR	TE	
Q311			2SD1757K	TRANSISTOR	TE	
Q311			2SD863(E,F)	TRANSISTOR	TE	

L : Scandinavia
Y : PX(Far East, Hawaii)
Y : AAFES(Europe)
K : USA
T : Europe
X : Australia
P : Canada
E : Europe
M : Other Areas
C : China
7 : KR-V7080
8 : KR-V8080
Δ indicates safety critical components.

* New Parts
Parts without **Parts No.** are not supplied.
Les articles non mentionnés dans le **Parts No.** ne sont pas fournis.
Teile ohne **Parts No.** werden nicht geliefert.

15

Ref. No	Add-ress	New Parts	Parts No.	Description	Desti-nation	Re-marks
W420.421			R92-0670-05	CHIP R	TE	
W422			R92-0670-05	CHIP R	KPYXMC	
W426			R92-0670-05	CHIP R	KPYXMC	
W446			R92-0670-05	CHIP R	KPYXMC	
W448			R92-0670-05	CHIP R	KPYXMC	
W501.502			R92-0679-05	CHIP R	YMC	
W503			R92-0679-05	CHIP R	KPYXMC	
W504			R92-0679-05	CHIP R	KPYXMC	
W505-508			R92-0679-05	CHIP R	KPYXMC	
W510-512			R92-0679-05	CHIP R	KPYXMC	
S1			S70-0031-05	TACT SWITCH (REMOTE POWER)	TE	
S2-4			S70-0031-05	TACT SWITCH (RDS)	TE	
S5-36			S70-0031-05	TACT SWITCH	TE	
S39			S40-1138-05	PUSH SWITCH (MAIN POWER)	TE	
S401			S62-0034-05	SLIDE SWITCH (DE-EMPHASIS)	TE	
S37			T99-0559-05	ROTARY ENCODER(VOLUME CONTROL)	YMC	
S38			T99-0571-05	ROTARY ENCODER(INPUT SELECTOR)	YMC	
D1			HZS6.2N(B2)	ZENER DIODE	YMXMTE	
D1			RD6.2ES(B2)	ZENER DIODE	YMXMTE	
D2.3			HSS104	DIODE	XTE	
D2.3			1SS133	DIODE	XTE	
D4			MA111	DIODE	TE	
D6.7			HSS104	DIODE	TE	
D6.7			1SS133	DIODE	TE	
D8			MA111	DIODE	TE	
D9-14			HSS104	DIODE	TE	
D9-14			1SS133	DIODE	TE	
D16			HSS104A	DIODE	TE	
D16			1SS131	DIODE	TE	
D21-28			HSS104A	DIODE	TE	
D21-28			1SS131	DIODE	TE	
D29			HSS104A	DIODE	TE	
D29			1SS131	DIODE	TE	
D31			HSS104A	DIODE	TE	
D31			1SS131	DIODE	TE	
D32-35			HSS104	DIODE	TE	
D32-35			1SS133	DIODE	TE	
D301.302			HSS104	DIODE	TE	
D301.302			1SS133	DIODE	TE	
D303			HZS5.1N(B2)	ZENER DIODE	KPYXMC	
D303			HZS3.3N(B2)	ZENER DIODE	KPYXMC	
D304			HZS8.2N(B2)	ZENER DIODE	KPYXMC	
D304			RD3.3ES(B2)	ZENER DIODE	KPYXMC	
D304			RD8.2ES(B2)	ZENER DIODE	KPYXMC	
D305			HSS104	DIODE	TE	
D305			1SS133	DIODE	TE	
D306			HZS3.3N(B2)	ZENER DIODE	TE	
D306			RD3.3ES(B2)	ZENER DIODE	TE	
D307			HSS104	DIODE	TE	
D307			MA111	DIODE	TE	
D307			1SS133	DIODE	TE	
D308			HSS104	DIODE	TE	
D308			1SS133	DIODE	TE	

L : Scandinavia
Y : PX(Far East, Hawaii)
Y : AAFES(Europe)
K : USA
T : Europe
X : Australia
P : Canada
E : Europe
M : Other Areas
C : China
7 : KR-V7080
8 : KR-V8080
Δ indicates safety critical components.

KR-V7080/V8080

PARTS LIST

17

* New Parts
Parts without **Parts No.** are not supplied.
Les articles non mentionnés dans le **Parts No.** ne sont pas fournis.
Teile ohne **Parts No.** werden nicht geliefert.

Ref. No	Add-ress	New Parts	Parts No.	Description	Desti-nation	Re-marks
C312			2SD1757K	TRANSISTOR	TE	
C316			2SC4081(R,S)	TRANSISTOR	TE	
C317		*	2SC4116(Y,GR)	TRANSISTOR	TE	
C317		*	2SA1576A(R,S)	TRANSISTOR	TE	
C317		*	2SA1586(Y,GR)	TRANSISTOR	TE	
C318			2SC4081(R,S)	TRANSISTOR	TE	
C318			2SC4116(Y,GR)	TRANSISTOR	TE	
C402		*	2SA1576A(R,S)	TRANSISTOR	KPYXMC	
C402		*	2SA1586(Y,GR)	TRANSISTOR	KPYXMC	
C404		*	2SA1576A(R,S)	TRANSISTOR	KPYXMC	
C404			2SA1586(Y,GR)	TRANSISTOR	KPYXMC	
C407_408			2SC4081(R,S)	TRANSISTOR	YMC	
C407_408			2SC4116(Y,GR)	TRANSISTOR	YMC	
C409_410			2SD1757K	TRANSISTOR	KPYXMC	
C411		*	2SA1576A(R,S)	TRANSISTOR	KPYXMC	
C411			2SA1586(Y,GR)	TRANSISTOR	KPYXMC	
C601-603			DTC124EU	DIGITAL TRANSISTOR		
C601-603			UN5212	TRANSISTOR		
C604			2SC3940A(R,S)	TRANSISTOR		
C604			2SD863(E,F)	TRANSISTOR		
A1			W02-1174-05	ELECTRIC CIRCUIT MODULE	TE	
A301			W02-2509-05	FM FRONT-END ASSY	KPYXMC	
A301			W02-2512-05	FM FRONT-END ASSY	KPYXMC	

L : Scandinavia
Y : PX(Far East, Hawaii)
V : AAFES(Europe)

K : USA
T : Europe
X : Australia

P : Canada
E : Europe
M : Other Areas

C : China

7 : KR-V7080
8 : KR-V8080

▲ indicates safety critical components.

KR-V7080/V8080

SPECIFICATIONS

Audio section

Rated power output at the STEREO operation

100 watts per channel minimum RMS, both channels driven at 8 Ω, from 20 Hz to 20,000 Hz with no more than 0.06 % total harmonic distortion. (FTC)

Power output at the SURROUND operation

Front

100 watts per channel minimum RMS, both channels driven, at 8 Ω, 1 kHz with no more than 0.7 % total harmonic distortion. (FTC)

Center

100 watts minimum RMS at 8 Ω, 1 kHz with no more than 0.7 % total harmonic distortion. (FTC)

Rear

30 watts per channel minimum RMS, both channels driven, at 8 Ω, 1 kHz with no more than 0.7 % total harmonic distortion. (FTC)

Total harmonic distortion

.....0.01 % (1 kHz, 50 W, 8 Ω)

Signal to noise ratio (IHF'66)

PHONO (MM)75 dB

LINE (CD)95 dB

Input sensitivity / impedance

PHONO (MM)2.5 mV / 47 kΩ

CD, TAPE, VIDEO200 mV / 47 kΩ

Tone controls

BASS ± 8 dB (at 100 Hz)

TREBLE ± 8 dB (at 10 kHz)

LOUDNESS control at - 30 dB VOLUME level

.....+ 6 dB (100 Hz)

Output level / impedance

Sub woofer preout1.0 V / 2.2 kΩ

Video section

VIDEO inputs / outputs (Composite)1 Vp-p / 75 Ω

FM Tuner section

Tuning frequency range87.5 MHz ~ 108 MHz

Usable sensitivity

MONO1.2 μV (75 Ω) / 13.2 dBf
(75 kHz dev., S/N 30 dB)

50 dB quieting sensitivity

STEREO32 μV (75 Ω) / 41.2 dBf
(75 kHz dev.)

Total harmonic distortion (1 kHz)

MONO0.6 % (65.2 dBf input)

STEREO0.7 % (65.2 dBf input)

Signal to noise ratio (1 kHz 75 kHz dev.)

MONO75 dB (65.2 dBf input)

STEREO68 dB (65.2 dBf input)

Stereo separation

1 kHz40 dB

Selectivity (IHF ±400 kHz)50 dB

Frequency response30 Hz ~ 15 kHz, + 0.5 dB, - 3.0 dB

AM Tuner section

Tuning frequency range530 kHz ~ 1,700 kHz

Usable sensitivity (30 % mod., S/N 20 dB)

.....12 μV / (500 μV / m)

Signal to noise ratio (30 % mod., 1 mV input)48 dB

Total harmonic distortion0.7 %

Selectivity30 dB

General

Power consumption4 A

AC outlet

SWITCHED2: (total 65 W, 0.54 A max.)

DimensionsW : 440 mm (17-5 / 16")

H : 148 mm (5-13 / 16")

D : 389 mm (15-5 / 16")

Weight (net)10.2 kg (22.5 lb)